



Sink

**KS**

Sink - 2 bowls - Standard Edge (STD) - for standard built in installation

Code: 2182 460

## Product Details

Materials/Finishes	Microfoster finish AISI 304 stainless steel
Cabinet	80-90 cm
Dimensions	860x500 mm
Edge/Installation Type	Standard Edge (STD) - for standard built in installation
Cut out	840x480 mm
Number of bowls	2 bowls
Bowl dimension	340x400 mm
Waste fitting	3,5" waste
Mixer holes	One standard tap hole
Standard fittings	fixing brackets, gasket, waste fitting, overflow and siphon. Packing: single carton box.

## Features



Added value



Deep bowls



Basket 3,5" waste fitting







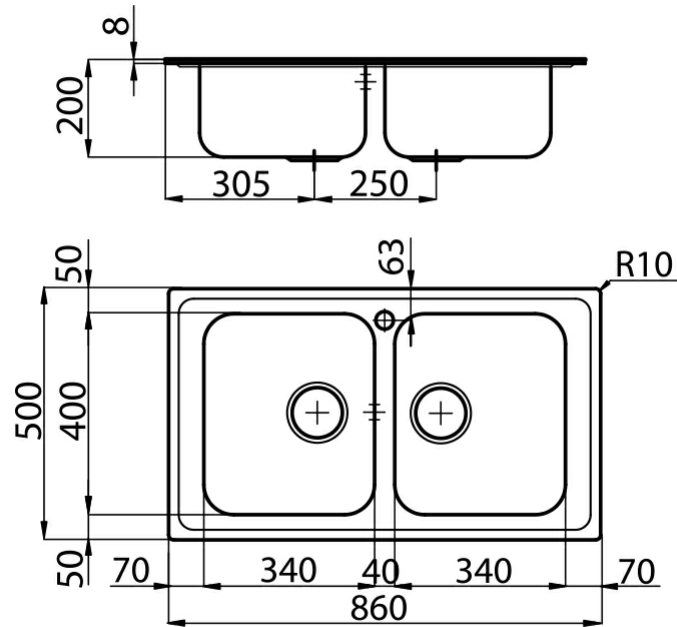



Sliding brackets

### Dimensions



### Optional accessories

- |   |   |   |   |  |   |   |
|---|---|---|---|--|---|---|
|  |  |  |  |  |  |   |
| iroko-wood chopping board<br>8647 000   | iroko-wood sliding chopping board<br>8644 041                                       | glass chopping board 8631 300   | glass chopping board 8633 300   | iroko-wood sliding chopping board<br>8643 000  | hpde chopping board 8657 001  |   |
|   |  |  |  |  |  |  |
| hpde twin chopping board 8644 101   | iroko-wood chopping board with stainless steel colander 8644 042                    | graters kit with ring-holder and food collection tray 8159 101                      | white bowl 8153 100   | stainless steel basket 8611 000  | stainless steel plate rack 8100 303   | stainless steel plate rack 8100 301   |

07-08-2019 15:01:15