



Gas Hob

Foster Milano

Gas Hob 82 cm - Four burners - FILOTOP Edge - for flush-mount (FT) or over-mount (FTS) installation

Code: 7637 000

Product Details

Materials/finishes	Foster-brushed finish AISI 304 stainless steel
Edge/installation type	FILOTOP Edge - for flush-mount (FT) or over-mount (FTS) installation
Cooking elements	Four burners
Grids	Cast iron grids and enamelled burner covers
Ignition	Under-knob electric ignition
Safety	Safety valves with ultra-rapid thermocouples
Dimension	820x560 mm
Cut out	Vedi scheda tecnica
Total power	9.950 W
- Rapid	3.000 W
- Semirapid	1.750 W
- Dual	4.200 W
- Auxiliary	1.000 W
Gas type	Tested for installation with natural gas, LPG nozzle set included
Power Supply	220-240 V; 50.60 Hz
Equipment	1 x <i>Cast iron wok support 9601 668</i>

Features



Special burners



Aeo burners



Cast iron grids



56 cm deep



XXl grids



Under-knob ignition



Safe cooking

Dimensions

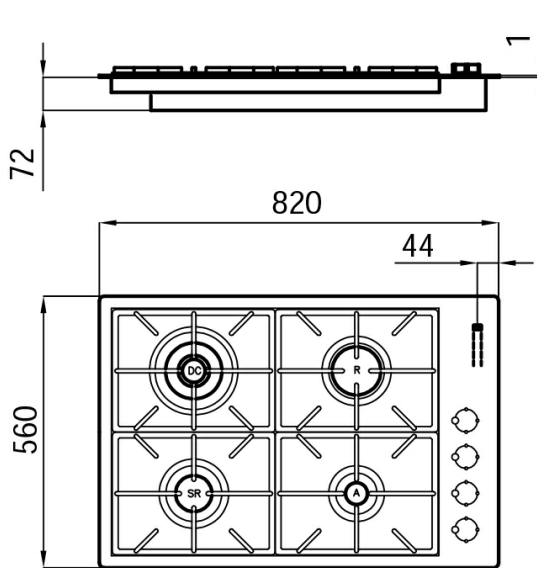

Cut out drawing

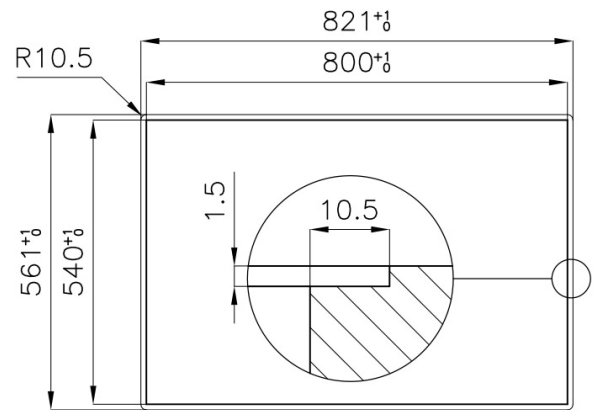

05-08-2019 16:59:45