



Sink

Marine

Sink - 1 bowl - Flat Edge - for standard built-in installation (SF)

Code: 1975 961 DX (Vasca a destra)

Code: 1975 962 SX (Vasca a sinistra)

Product Details

Materials/Finishes	Foster-brushed finish AISI 316 stainless steel
Cabinet	45 cm
Dimensions	873x513 mm
Edge/Installation Type	Flat Edge - for standard built-in installation (SF)
Cut out	840x480 mm
Number of bowls	1 bowl
Bowl dimension	362,5x400 mm
Waste fitting	3,5" waste
Mixer holes	One standard tap hole
Standard fittings	fixing brackets, gasket, waste fitting, overflow and siphon. Packing: single carton box.

Features



Marine stainless steel



Basket 3,5" waste fitting



2nd / 3rd hole available



Pre-installed gasket

Dimensions

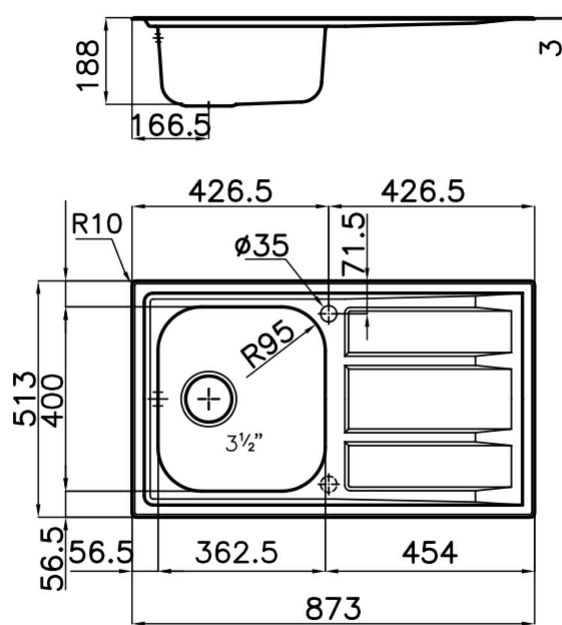

Optional accessories



glass chopping board 8631 300



hpde chopping board 8657 001



stainless steel basket 8611 000

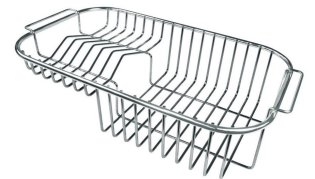

stainless steel plate rack 8100 301

Optional automatic waste fittings



automatic waste fitting 8407 000



automatic waste fitting 8407 100



lira automatic waste fitting 8407 102



lira automatic waste fitting 8407 103

06-08-2019 13:57:25

