

Canal équipé

Canaux équipés

Code: 3026 880



DÉTAILS

Bord d'installation

Sous-plan

Matériau

Acier inoxydable AISI 304

Finition

Brossée Foster

Textures

Satiné

Base

120 cm

Dimensions extérieures

1138 x 170 mm

Dimensions intérieures

1122 x 122 mm

Largeur

113,8 cm

Longueur

8 unité - Standard

Trou d'encastrement

Voir fiche technique

Équipement standard

Crochets de fixation, vidange, emballage en boîte

Vidange

Vidange de 1¼"

Clé de lecture pour les accessoires

Les longueurs des canaux et des accessoires sont indiquées en "unités". Pour la composition, la somme des "unités" des accessoires doit correspondre à la longueur en "unités" du canal.

DESSINS TECHNIQUES

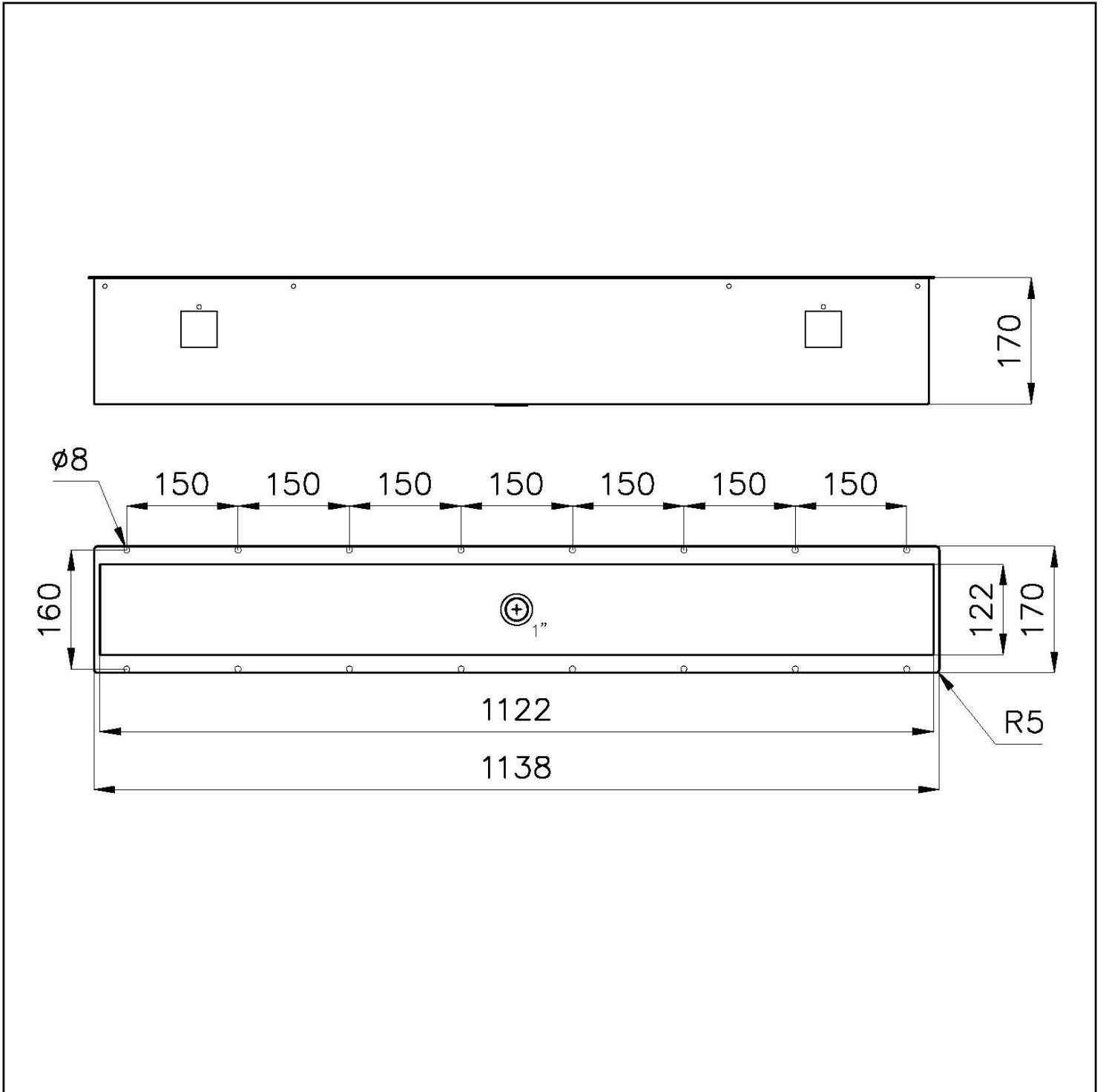

Sottotop/Undermount

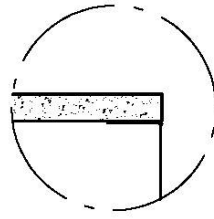

B-B:
Dettaglio installazione
Installation detail

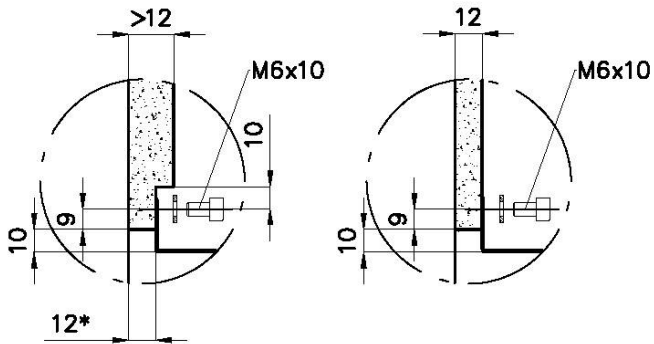

A-A:
Dettaglio installazione positive reveal e sistema di fissaggio
Installation detail with positive reveal and fixing system

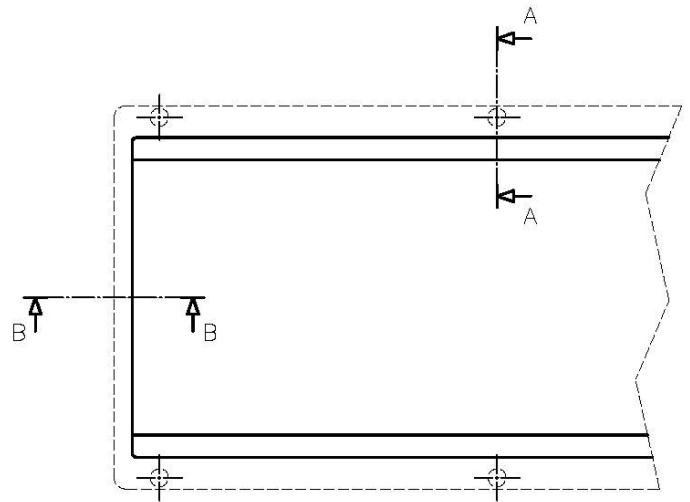

*spessore consigliato per un abbinamento perfetto con gli accessori
*recommended thickness for a perfect match with the accessories

Dimensioni per foratura top
Cut out size

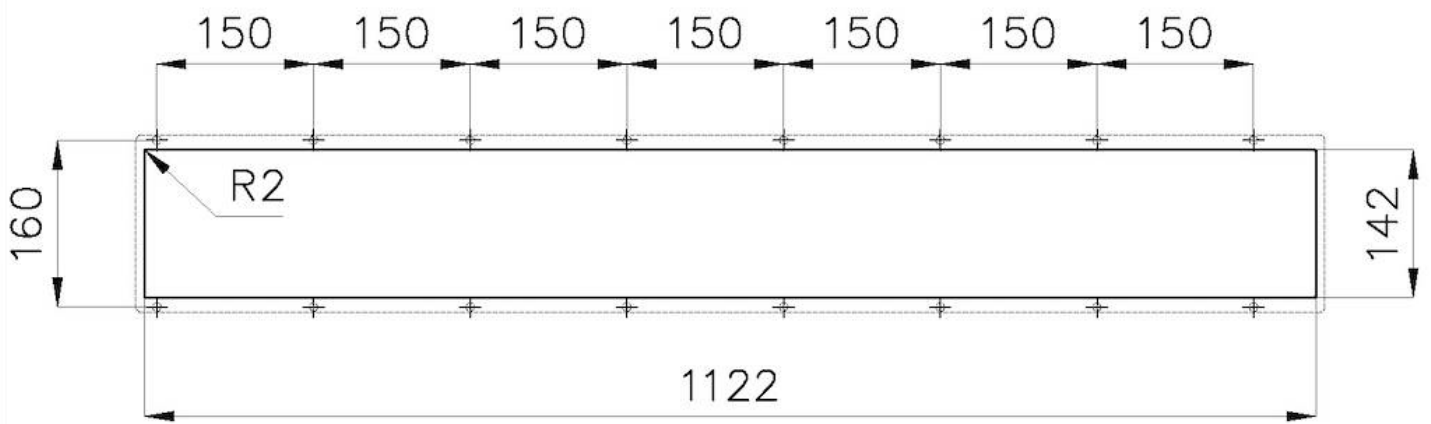

GALERIE

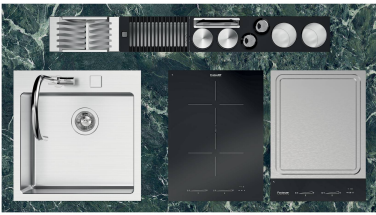

ACCESSOIRES OPTIONNELS



Cuvette perforée en acier inoxydable
8151 003



Kit "A"
8100 703



Kit "B"
8100 700



Kit "C"
8100 701



Kit "D"
8100 704



Kit "E"
8100 705



Kit "F"
8100 706



Kit "G"
8100 710



Kit "H"
8100 702



Kit "N"
8100 714



Porte-assiettes inox
1773 100



Porte-prises en acier inoxydable
8000 020



Stainless steel knife holder
8100 712