

## Diade equipped troughs

Equipped troughs

Code: 8100 800



### DETAILS

Edge/Installation Type Flush-mount | Top-mount | Undermount

Material AISI 304 stainless steel

Finish Foster brushed

Texture Brushed in line

Base 90 cm

External dimensions 320 x 164 mm

Internal dimensions 280 x 124 mm

Width 32 cm

Built-in hole [View sink technical data sheet](#)

Standard fittings

Fixing hooks, gasket, drain, boxed packing

---

Waste fitting

1¼" drain

---

## FEATURES

High thickness

1mm thick steel. A significant thickness, which guarantees the maximum sturdiness and durability.

---

## TECHNICAL DATA

8100 800

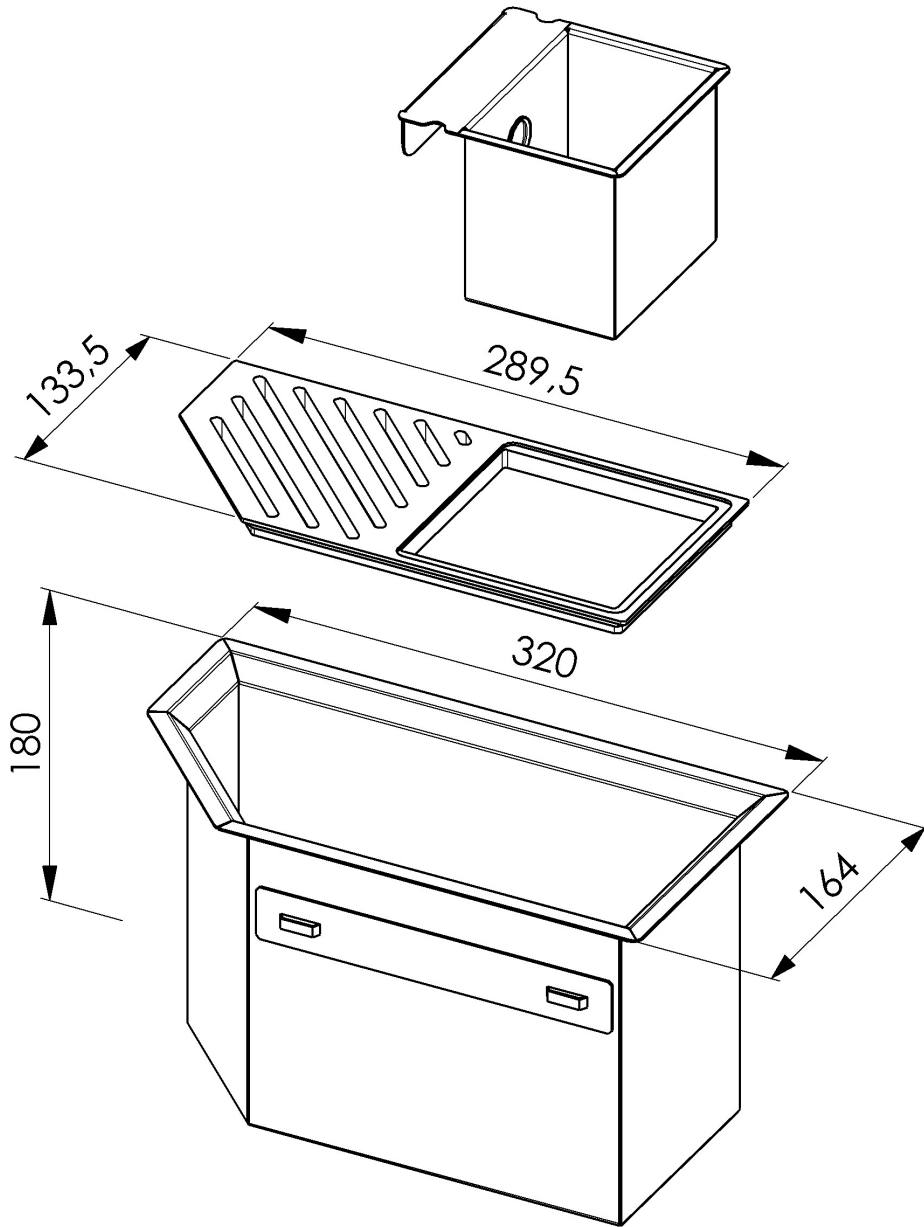

1 x Supporto black / 1 x Black support  
1 x Vaschetta AISI 304 / 1 x AISI 304 tray

## GALLERY

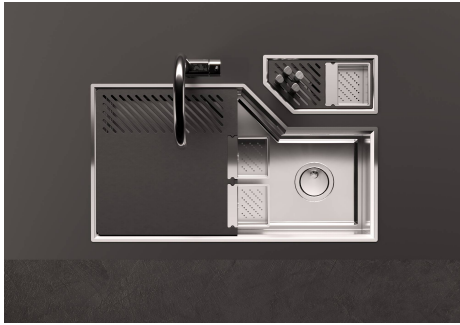

## RECOMMENDED PAIRINGS



**Sink Diade**  
3028 850



**Sink Diade**  
3028 000