

Diade equipped troughs Phantom



Equipped troughs

Code: 8100 003



DETAILS

Edge/Installation Type Phantom Base

Material AISI 304 stainless steel

Texture Brushed in line

Finish Foster brushed

Base 90 cm

External dimensions 310 x 154 mm

Internal dimensions 270 x 114 mm

Width 31 cm

Built-in hole [View sink technical data sheet](#)

Standard fittings

Fixing hooks, drain, boxed packing

Waste fitting

1¼" drain

FEATURES

High thickness

1mm thick steel. A significant thickness, which guarantees the maximum sturdiness and durability.

TECHNICAL DATA

8100 003

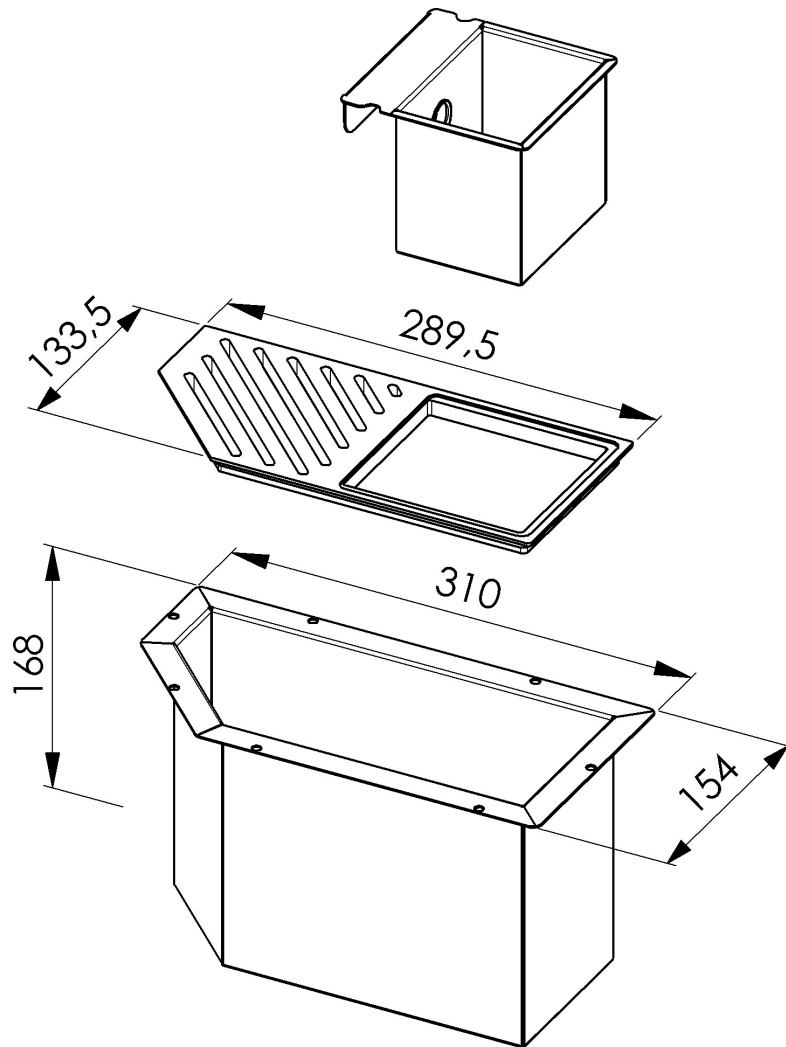

1 x Supporto black / 1 x Black support
1 x Vaschetta AISI 304 / 1x AISI 304 tray

GALLERY



RECOMMENDED PAIRINGS



Sink Diade
3028 555