

Cooker hob KE

Gas hobs

Code: 7603 032



DETAILS

Edge/Installation Type Standard (8 mm Edge)

Finish Foster brushed

Material AISI 304 stainless steel

Texture Brushed in line

Supply 220-240 V; 50/60 Hz

Dimensions 860x500 mm

Base size 90cm

Heating element Five burners

Built-in hole 840x480 mm

Grids Cast iron grids and enamelled burner covers

Width 86 cm

Total power 9.500 W

Auxiliary 2x1.100 W

Semirapid 2x1.750 W

Triple crown 3.800 W

Safety Safety valve with quick-acting thermocouple

Ignition Electric ignition under knob

Gas type Tested for installation with natural gas, LPG nozzle set included.

Type Gas Hob

FEATURES

Cast iron grids Cast-iron is the ideal material for an hob grid, this due to the manifold properties characterising it: high heat capacity that improves cooking performance; high weight and stability that improve safety; sturdiness that preserves the hob's original aspect over time; easy cleaning.

lil series burners lil ^ series burners: 20% gas savings. They guarantee an efficiency well above the European standards. Furthermore, the improved combustion of gas allows the development of higher powers. From the point of view of safety, the blocking system between the cover and the flame-spreader guarantees perfect positioning and greater ease of cleaning.

Inclined recess

A deep and inclined recess houses the burners and grigs, allowing to create a single work surface. The inclination also makes it extremely easy to clean the edges.

Safe cooking

All Foster cooker hobs are equipped with safety valves. They shut off the gas supply very quickly if the flame accidentally goes out.

Special burners

Many Foster hobs are equipped with special burners, with two or three rings of fire that greatly increase the power delivered and the heated surface. In the DUAL models the two fire crowns also have independent ignition, making these burners perfect for both intensive and delicate cooking.

Ultra-flat hob

Design meets functionality in the the ultra-flat models. Elegant grids that form a generously sized overall surface.

Under-knob ignition

The utmost freedom of movement with electronic under-knob ignition, a common feature of all models that allows a one-hand ignition of the burner.

TECHNICAL DATA

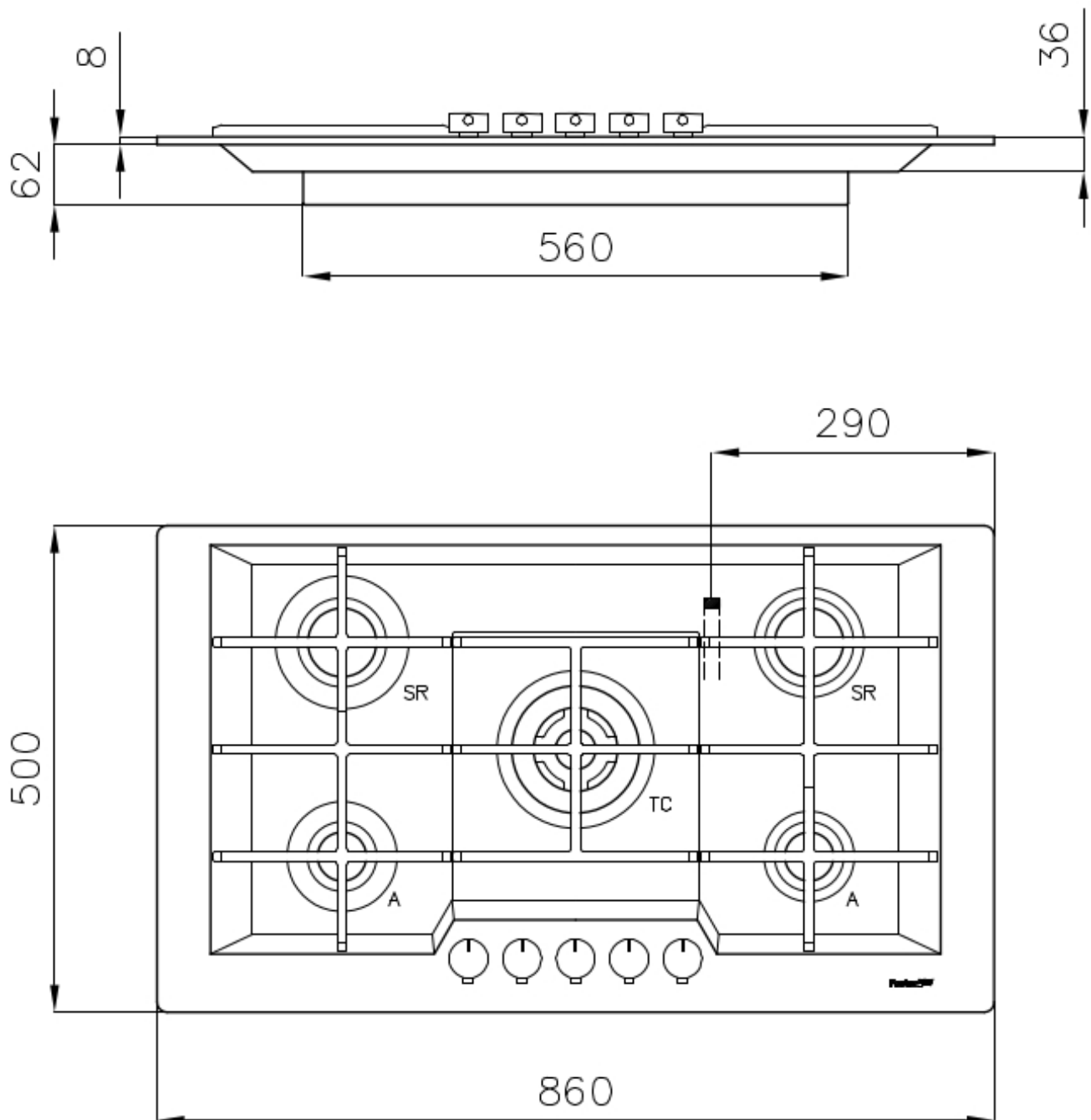

GALLERY



OPTIONAL ACCESSORIES



Cast iron wok support

RECOMMENDED PAIRINGS



Hood Amélie



Sink KE Filotop