

Cooker hob S4000

Gas hobs

Code: 7271 032



DETAILS

Edge/Installation Type Flush-mount | Top-mount

Finish Foster brushed

Material AISI 304 stainless steel

Texture Brushed in line

Supply 220-240 V; 50/60 Hz

Dimensions 920x520 mm

Base size 90cm

Heating element Five burners

Built-in hole [View technical data sheet](#)

Grids Cast iron grids and enamelled burner covers

Width 92 cm

Total power 11.400 w

Auxiliary 1.100 W

Semirapid 2x1.750 W

Rapid 3.000 W

Triple crown 3.800 W

Safety Safety valve with quick-acting thermocouple

Ignition Electric ignition under knob

Gas type Tested for installation with natural gas, LPG nozzle set included.

Type Gas Hob

EQUIPMENT

1 x Cast iron wok support 9601
668

FEATURES

Cast iron grids

Cast-iron is the ideal material for an hob grid, this due to the manifold properties characterising it: high heat capacity that improves cooking performance; high weight and stability that improve safety; sturdiness that preserves the hob's original aspect over time; easy cleaning.

lil series burners

lil series burners: 20% gas savings. They guarantee an efficiency well above the European standards. Furthermore, the improved combustion of gas allows the development of higher powers. From the point of view of safety, the blocking system between the cover and the flame-spreader guarantees perfect positioning and greater ease of cleaning.

Safe cooking

All Foster cooker hobs are equipped with safety valves. They shut off the gas supply very quickly if the flame accidentally goes out.

Special burners

Many Foster hobs are equipped with special burners, with two or three rings of fire that greatly increase the power delivered and the heated surface. In the DUAL models the two fire crowns also have independent ignition, making these burners perfect for both intensive and delicate cooking.

Ultra-flat hob

Design meets functionality in the the ultra-flat models. Elegant grids that form a generously sized overall surface.

Under-knob ignition

The utmost freedom of movement with electronic under-knob ignition, a common feature of all models that allows a one-hand ignition of the burner.

TECHNICAL DATA

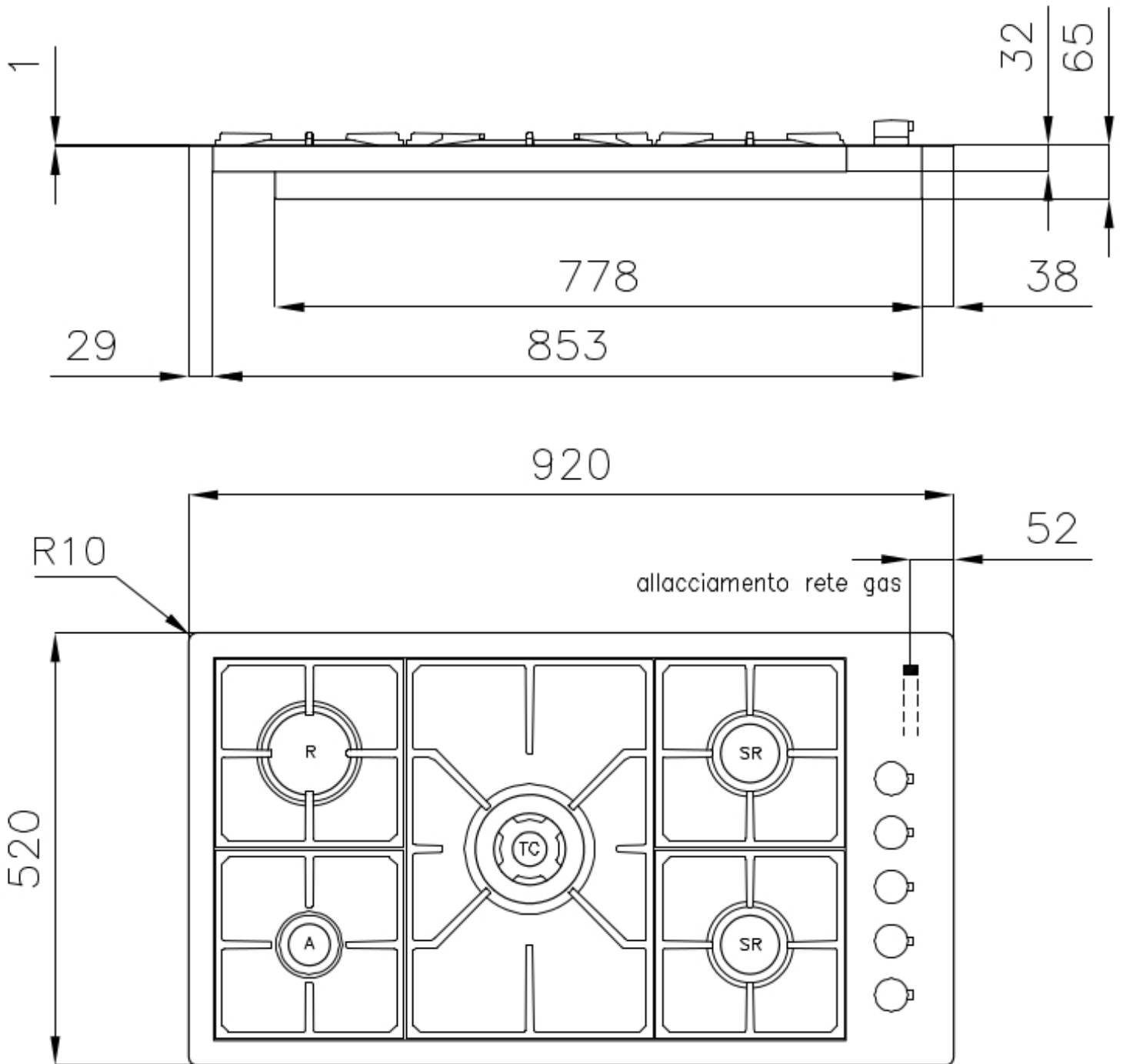

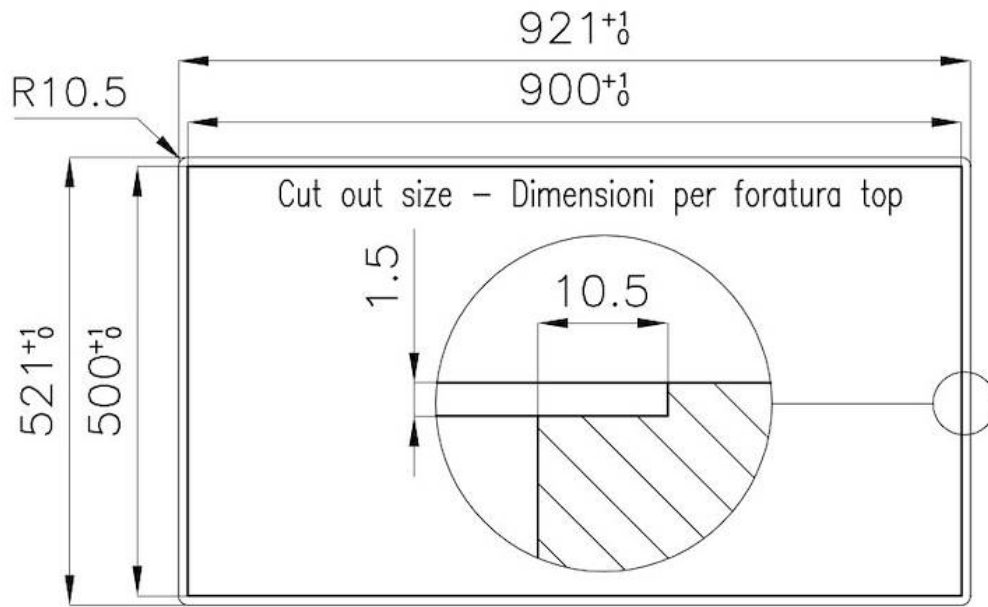

FT

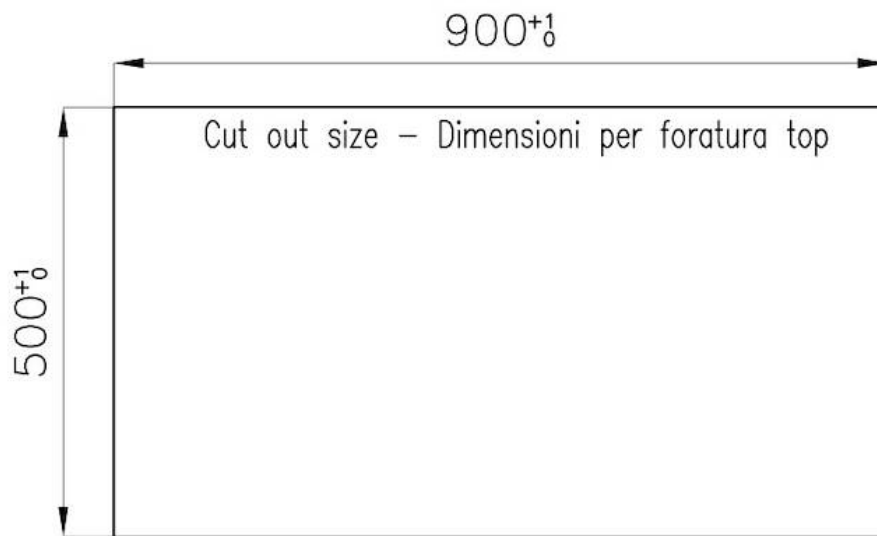

FTS

GALLERY



EQUIPMENT



Cast iron wok support

OPTIONAL ACCESSORIES



Cast iron pot support

RECOMMENDED PAIRINGS



Hood S4001 wall



Sink New Wave