

Sink Phantom Base

Kitchen Sinks

Code: 5557 140



DETAILS

Material	AISI 304 stainless steel
Texture	Brushed in line
Dimensions	740x430 mm for 12 mm thick sheets
Standard fittings	Drain, Foster overflow and universal corrugated pipe (for installing different overflows), Boxed packing
Built-in hole	View technical data sheet
Bowl dimension	710x400mm
Number of bowls	1 bowl
Waste fitting	3,5" drain

FEATURES

PHANTOM BASE - 12 mm

The Phantom BASE sink's bottoms are specifically engineered to be coupled with sinks made out of slabs. The perimetric trough makes for a simple and perfect installation. This version of Phantom BASE is meant for slabs of 12mm thickness.

PHANTOM BASE WITHOUT WELDING

The steel bottom Phantom BASE solves the problem of water draining of slab sinks, because the slope built into the moulded bottom ensures perfect draining. The radius and sloped profile of Phantom BASE guarantee great practicality and hygiene in everyday cleaning.

High thickness

1mm thick steel. A significant thickness, which guarantees the maximum sturdiness and durability.

Small radius

Bowls with squared shapes with a modern design and an increased capacity, for a minimal aesthetics connected with an extreme practicality.

Perimetral overflow

The overflow is always a security on the Foster sinks that prevents the overflow of water in case of oversights. The perimeter drain solution improves aesthetics thanks to its square and essential shape.

TECHNICAL DATA

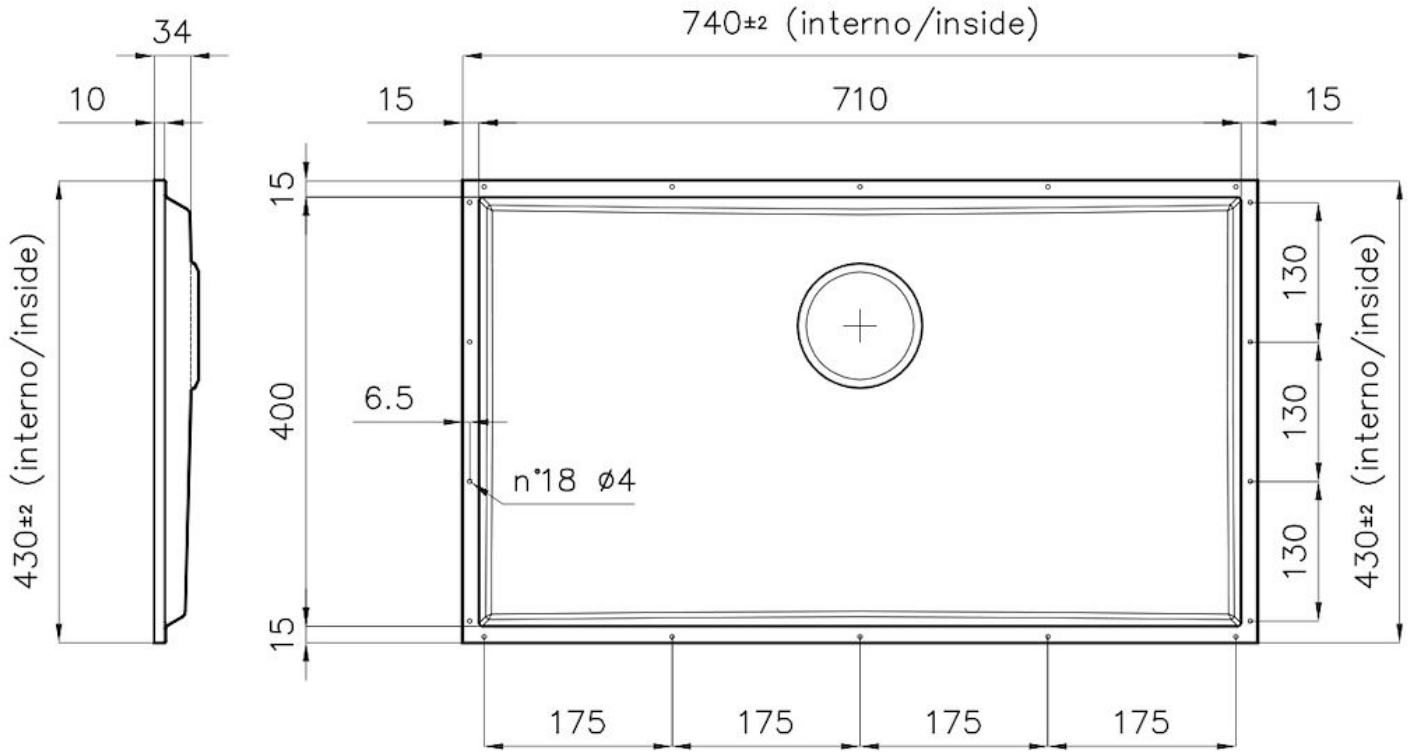

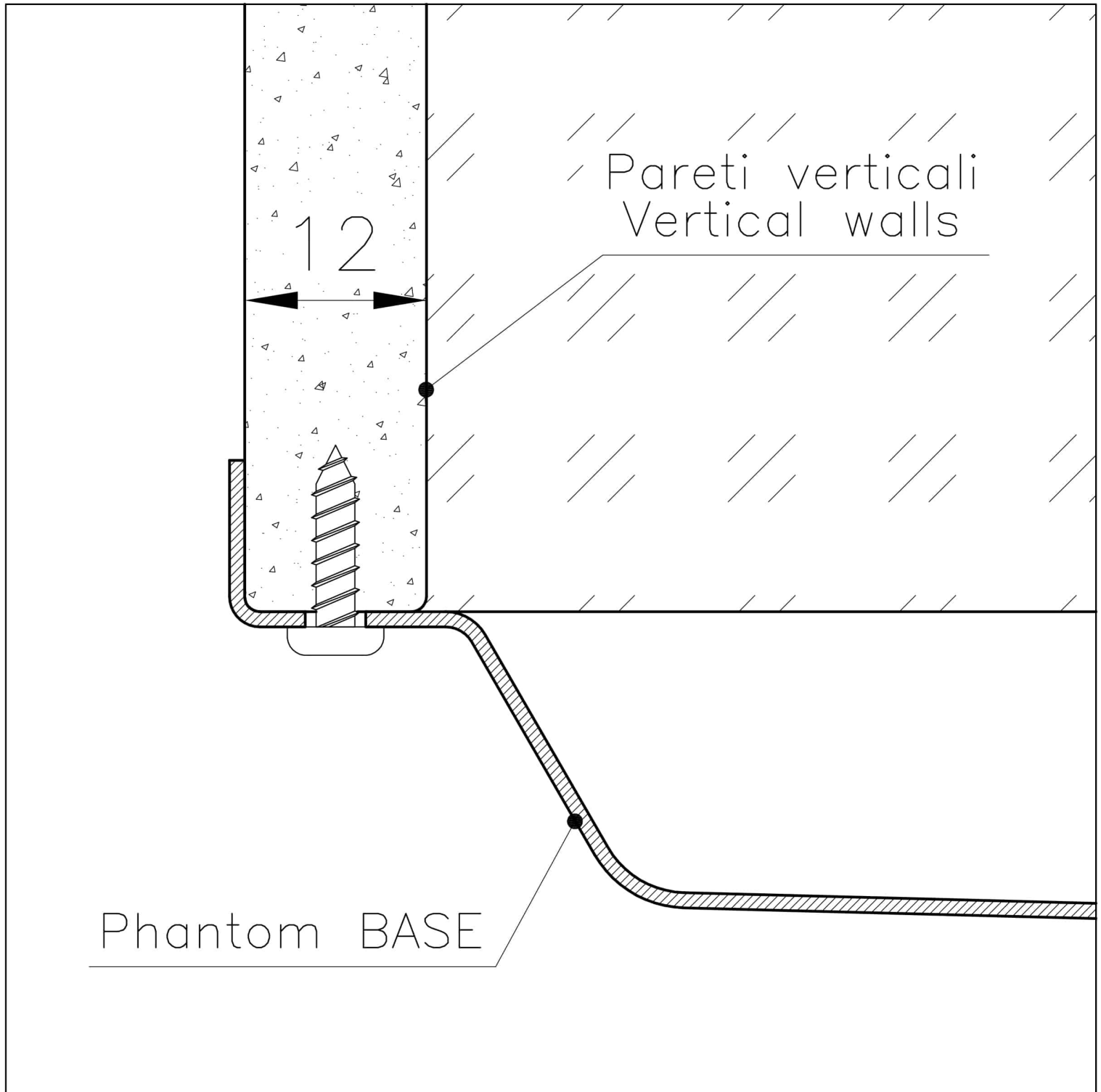

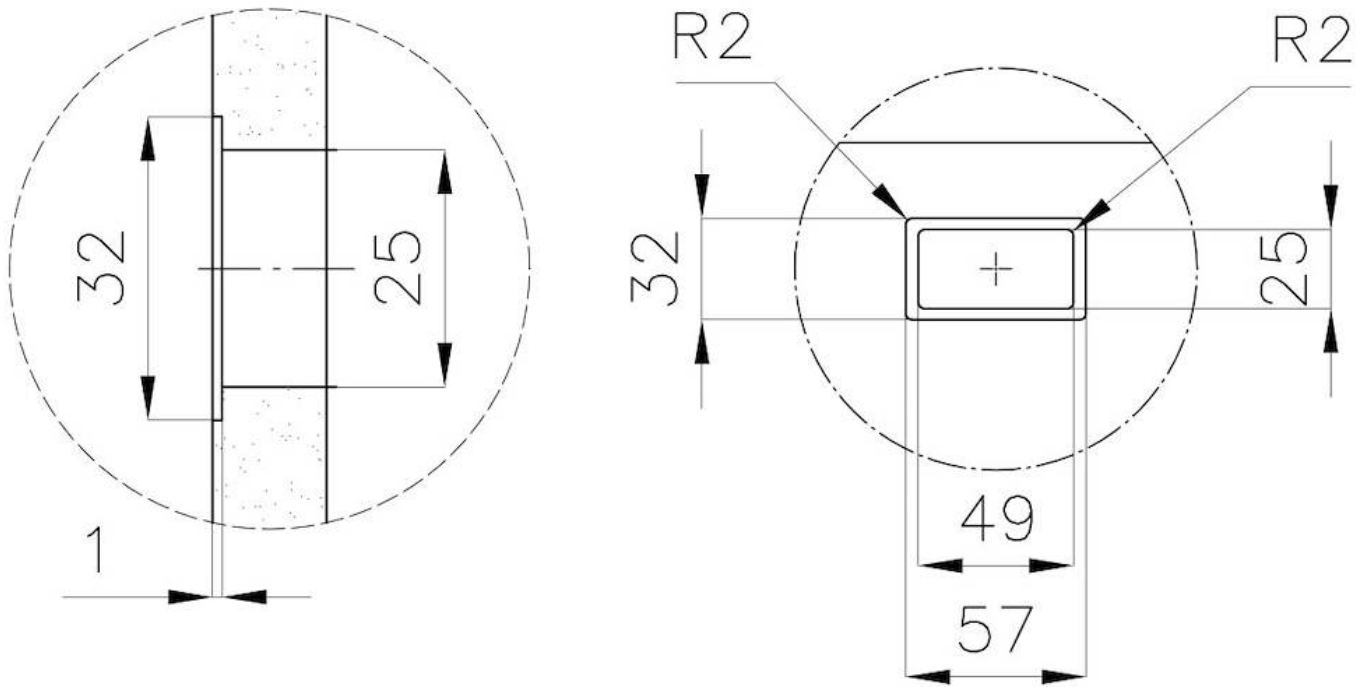

DETTAGLIO PER TROPPO PIENO / OVERFLOW DETAILS

GALLERY

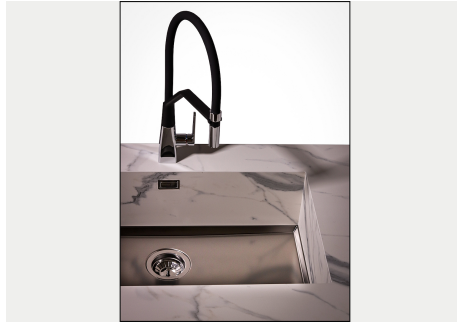

OPTIONAL ACCESSORIES



Cestello inox



HPDE Chopping board



Stainless steel plate rack



White basket



White bowl

WARNING:

The accessories 8159101, 8100303,8151000 are only usable in combination with 8644101

RECOMMENDED PAIRINGS



Mixer Tap FL



Mixer Tap Omega



Mixer Tap Omega Plus

OPTIONAL AUTOMATIC WASTE FITTINGS



Automatic waste fitting



Gun Metal automatic waste fitting