

Sink Skin 800

Kitchen Sinks

Code: 4458 040



DETAILS

Edge/Installation Type	Flush-mount Top-mount
Material	AISI 304 stainless steel
Texture	Foster brushed
Base	90 cm
Dimensions	840 x 440 mm
Standard fittings	Fixing hooks, gasket, drain, overflow and siphon, boxed packing
Mixer holes	No standard holes
Built-in hole	View technical data sheet
Drainer	No

Width 84 cm

Bowl dimension 800 x 400 mm

Number of bowls 1 bowl

Waste fitting Drain SPACE 3,5"

Notes: As the product consists of a single seamless steel surface with no gaps or interstices, the use of garbage disposal and waste fitting with automatic control is not permitted.

FEATURES

ONE SEAMLESS STEEL SURFACE The waste-fitting and overflow are moulded on the sink. The product is therefore made out of one seamless steel surface, without gaps or interstices. A great plus in terms of hygiene.

Deep bowls This bowls reach an important depth, over 20 cm, thanks to the advanced production technology, that can be offer great capiciency and practicity in all the washing operations.

High thickness 1mm thick steel. A significant thickness, which guarantees the maximum sturdiness and durability.

Perimetral overflow The overflow is always a security on the Foster sinks that prevents the overflow of water in case of oversights. The perimeter drain solution improves aesthetics thanks to its square and essential shape.

Save space system Drain and siphon are designed to leave as much space as possible in the under-sink area, more and more useful today for theseparate waste collection systems.

Small radius Bowls with squared shapes with a modern design and an increased capacity, for a minimal aesthetics connected with an extreme practicity.

Space waste fitting The elegant SPACE steel cap closes the drain and leaves no visible residues collected in the basket below. Space also has a small footprint and allows the optimal use of the under-sink compartment.

TECHNICAL DATA

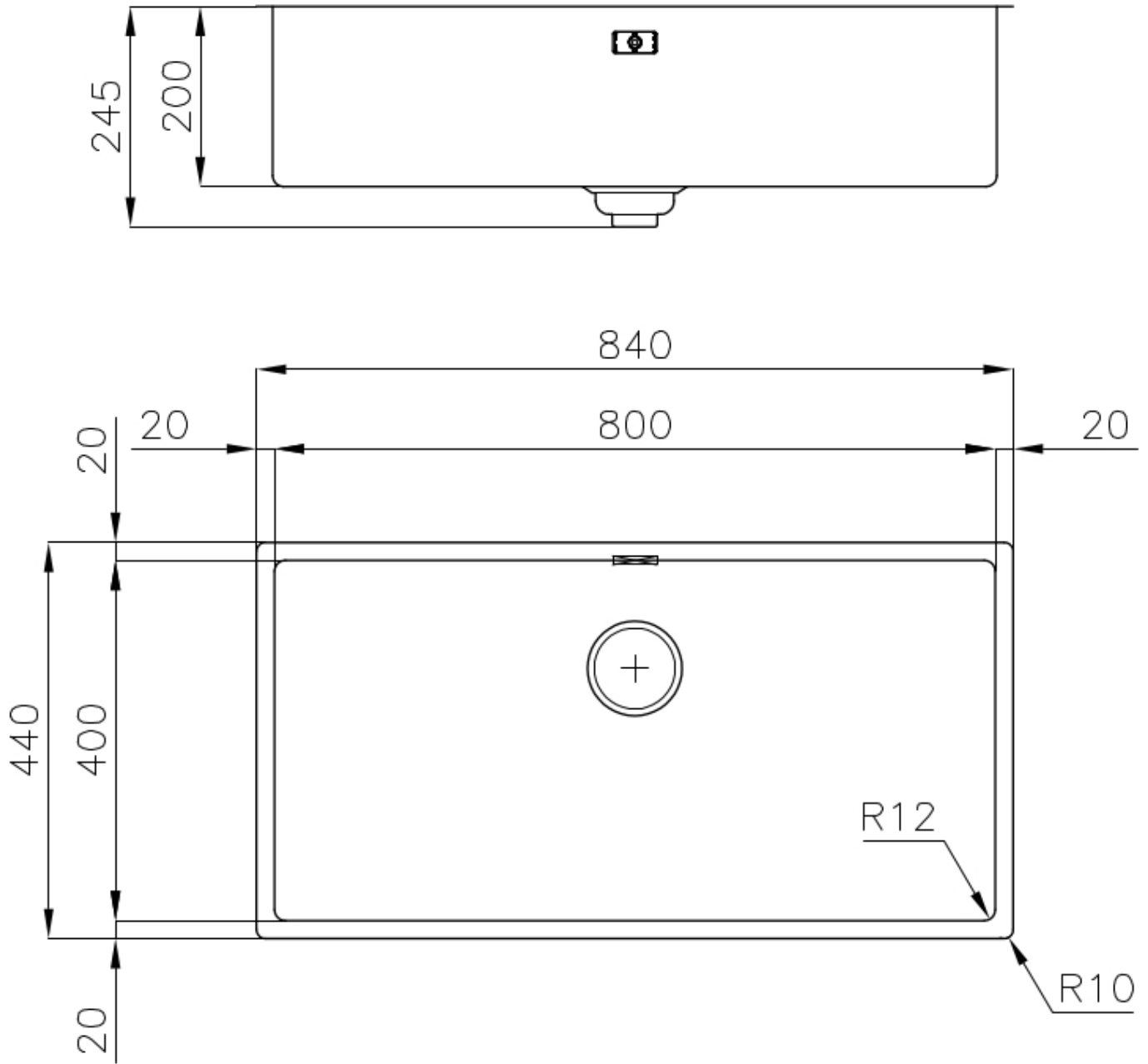

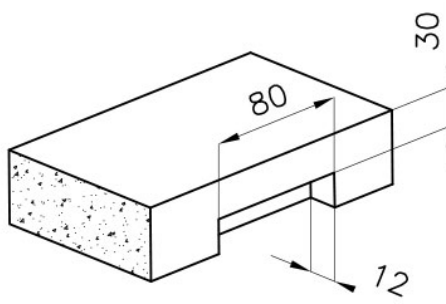

intaglio per il troppo-pieno
solo con top > 30 mm
recess for housing the over-flow
only for top > 30 mm

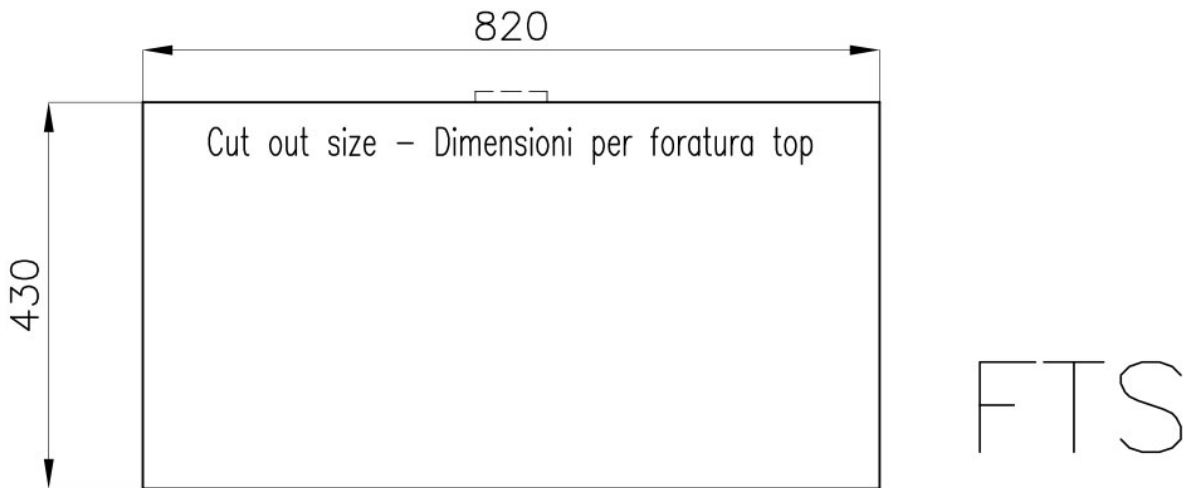
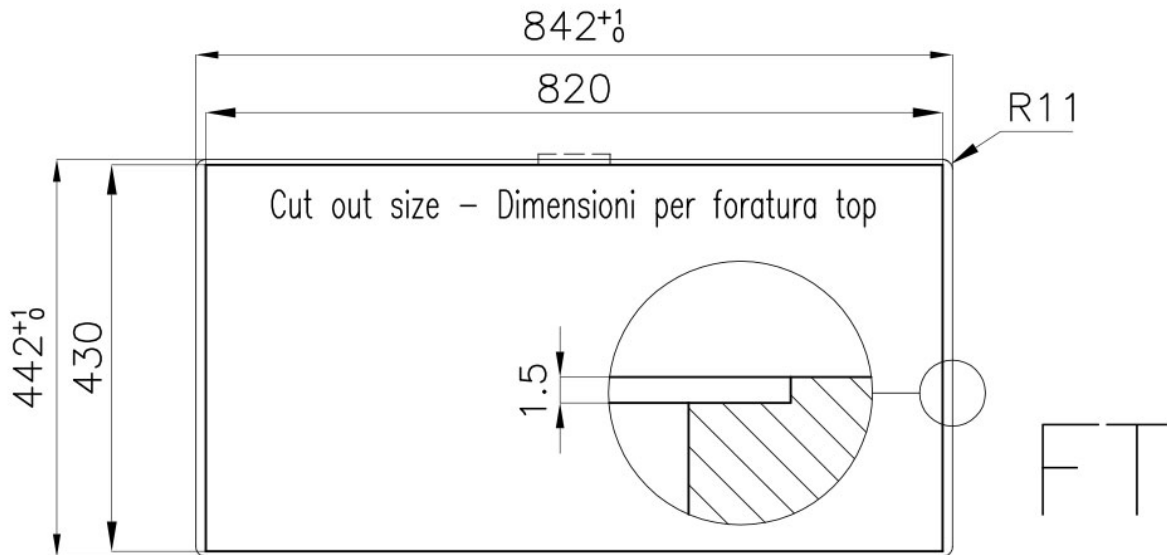

GALLERY

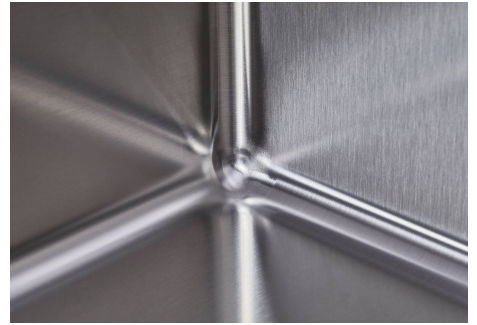

OPTIONAL ACCESSORIES



Glass chopping board
8631 300



HPDE Twin chopping board
8644 101

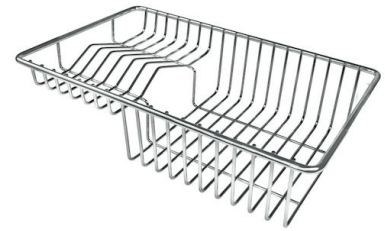

Stainless steel plate rack
8100 303
* only in combination with the accessory
8644 101

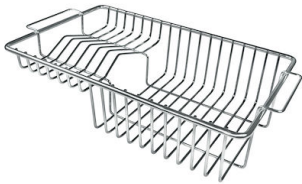

Stainless steel plate rack
8100 201



White bowl
8153 100



**Graters kit with ring-holder and
food collection tray**
8159 101
* only in combination with the accessory
8644 101



**Iroko-wood sliding chopping board
with stainless steel colander**
8644 044



Stainless steel perforated tray
8151 000
* only in combination with the accessory
8644 101

RECOMMENDED PAIRINGS



Mixer Tap Skin
8424 100



VELA PLUS satin
8497 120



VOLTA
8491 100