

Sink Phantom Edge R12 Gun Metal

Kitchen Sinks

Code: 4350 056



DETAILS

Coloring Gun Metal

Edge/Installation Type Undermount

Finish PVD

Material AISI 304 stainless steel

Texture Brushed in line

Base 60 cm

Dimensions 516x416 mm

Standard fittings Fixing hooks, drain, overflow and siphon, boxed packing

Mixer holes No standard holes

Built-in hole [View technical data sheet](#)

Drainer No

Width 51.6 cm

Bowl dimension 500x400mm

Number of bowls 1 bowl

Waste fitting 3,5" drain

FEATURES

Basket 3,5" waste fitting The drain is equipped with a large 3.5" drain, with the practical basket cap that prevents the discharge of solid parts.

Deep bowls This bowls reach an important depth, over 20 cm, thanks to the advanced production technology, that can be offer great capieny and practicity in all the washing operations.

Gun Metal The Gun Metal finish is obtained by treating steel with a physical process called PVD (Phisical Vacuum Deposition) which deposits particles of noble metals on the surface. The result is a unique and refined aesthetic effect, and an improvement of the mechanical properties of the steel which is more resistant to impact and scratches.

High thickness 1mm thick steel. A significant thickness, which guarantees the maximum sturdiness and durability.

Perimetral overflow The overflow is always a security on the Foster sinks that prevents the overflow of water in case of oversights. The perimeter drain solution improves aesthetics thanks to its square and essential shape.

Small radius Bowls with squared shapes with a modern design and an increased capacity, for a minimal aesthetics connected with an extreme practicity.

TECHNICAL DATA

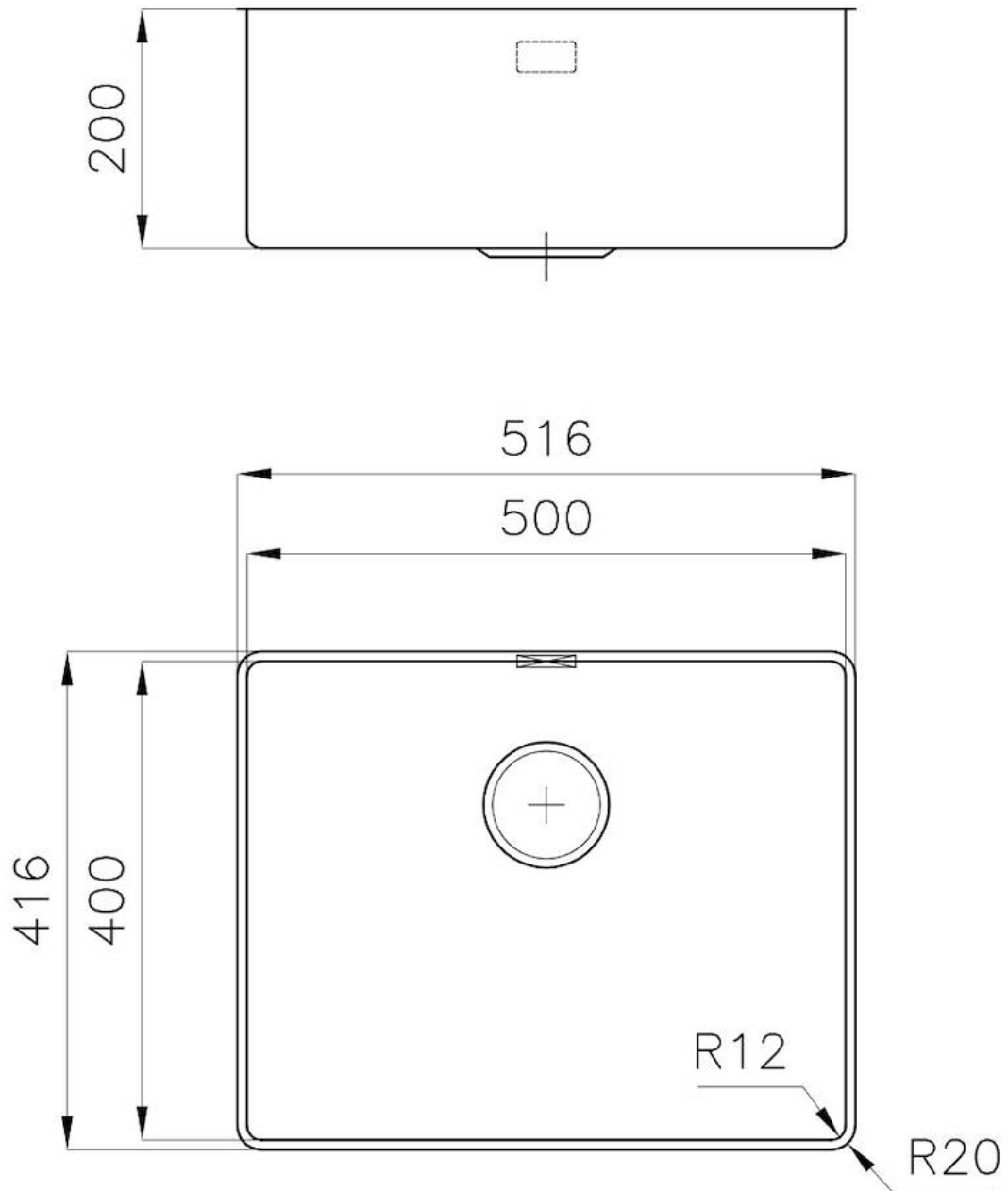

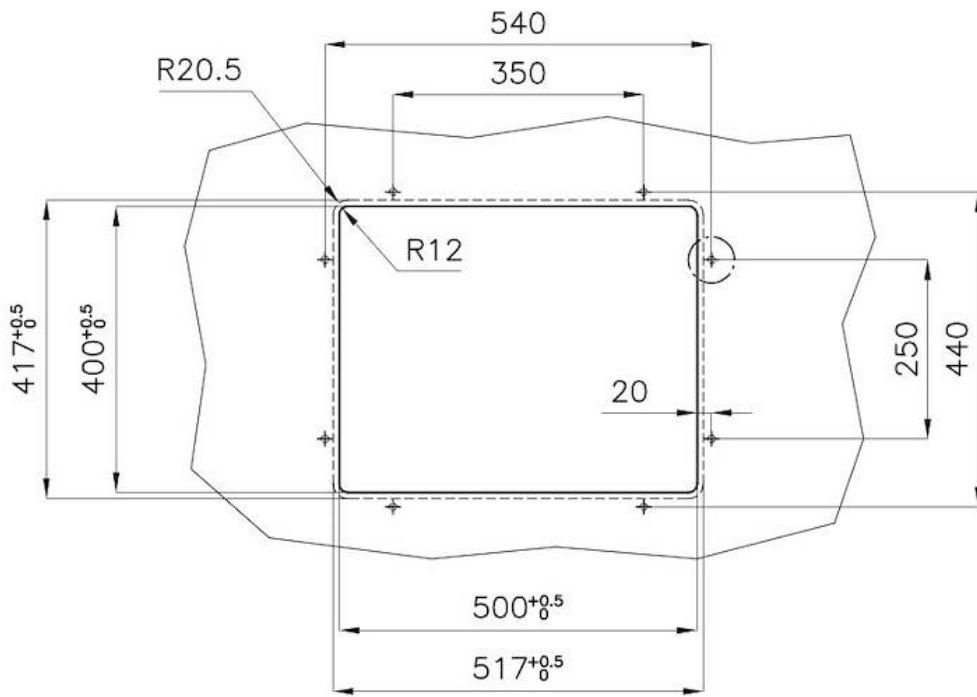

Posizioni fori per fissaggio
Fixing hole positions

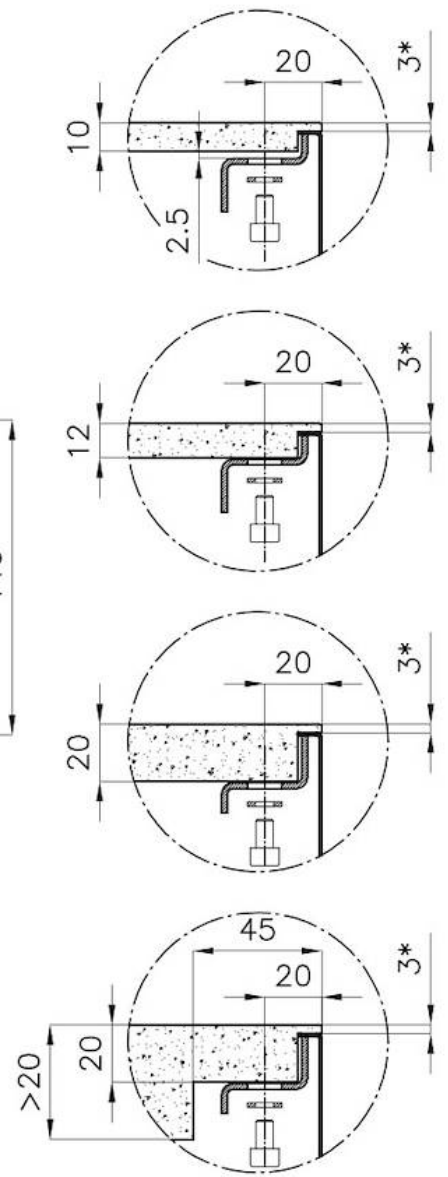

*spessore minimo consigliato che deve essere valutato in base alla resistenza del materiale.
*minimum recommended thickness that must be evaluated in reference to the material's resistance.

GALLERY



OPTIONAL ACCESSORIES



Cestello inox



Glass chopping board



HPDE Chopping board



HPDE Twin chopping board



Iroko-wood chopping board with stainless steel colander



Iroko-wood sliding chopping board



Iroko-wood twin chopping board



Stainless steel colander



Stainless steel plate rack



Stainless steel plate rack

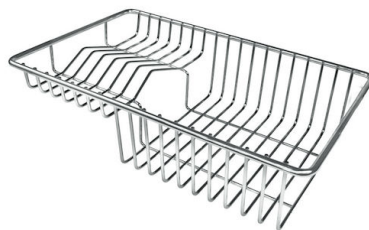

Stainless steel plate rack



White bowl



Graters kit with ring-holder and food collection tray



Stainless steel perforated tray

WARNING:

The accessories 8159101, 8100303,8151000 are only usable in combination with 8644101

The accessories 8100154, 8154000 are only usable in combination with 8644004

RECOMMENDED PAIRINGS



Mixer Tap 1/2 Circle



Mixer Tap Tre Alto

OPTIONAL AUTOMATIC WASTE FITTINGS



Automatic waste fitting



Space automatic waste fitting



Space automatic waste fitting



Space Light automatic waste fitting



Space Milano automatic waste fitting



Space Push automatic waste fitting