

## Sink Phantom Edge Vintage Gun Metal

Kitchen Sinks

Code: 4157 856



### DETAILS

Coloring Gun Metal

---

Edge/Installation Type Phantom Edge | Top 12 mm

---

Finish PVD

---

Material AISI 304 stainless steel

---

Texture Vintage

---

Base 80 cm

---

Dimensions 752x442 mm

---

Standard fittings Drain, overflow and siphon, boxed packing

---

Mixer holes No standard holes

---

Built-in hole [View technical data sheet](#)

---

Drainer No

---

Bowl dimension 710x400mm

---

Number of bowls 1 bowl

---

Waste fitting 3,5" drain

---

## FEATURES

**Gun Metal** The Gun Metal finish is obtained by treating steel with a physical process called PVD (Physical Vacuum Deposition) which deposits particles of noble metals on the surface. The result is a unique and refined aesthetic effect, and an improvement of the mechanical properties of the steel which is more resistant to impact and scratches.

---

**VINTAGE PVD** The prestigious PVD finish combines with the care for detail of the Vintage finish, to create a combination of unique elegance.

---

**PHANTOM EDGE** The Phantom Edge bowls are specifically manufactured for zero-edge installation. They are equipped with a perimetric fixing system onto which the worktop is lodged. The standard version is meant for 12mm-thick worktops.

---

**High thickness** 1mm thick steel. A significant thickness, which guarantees the maximum sturdiness and durability.

---

**Small radius** Bowls with squared shapes with a modern design and an increased capacity, for a minimal aesthetics connected with an extreme practicality.

---

**Perimetral overflow** The overflow is always a security on the Foster sinks that prevents the overflow of water in case of oversights. The perimeter drain solution improves aesthetics thanks to its square and essential shape.

---

## TECHNICAL DATA

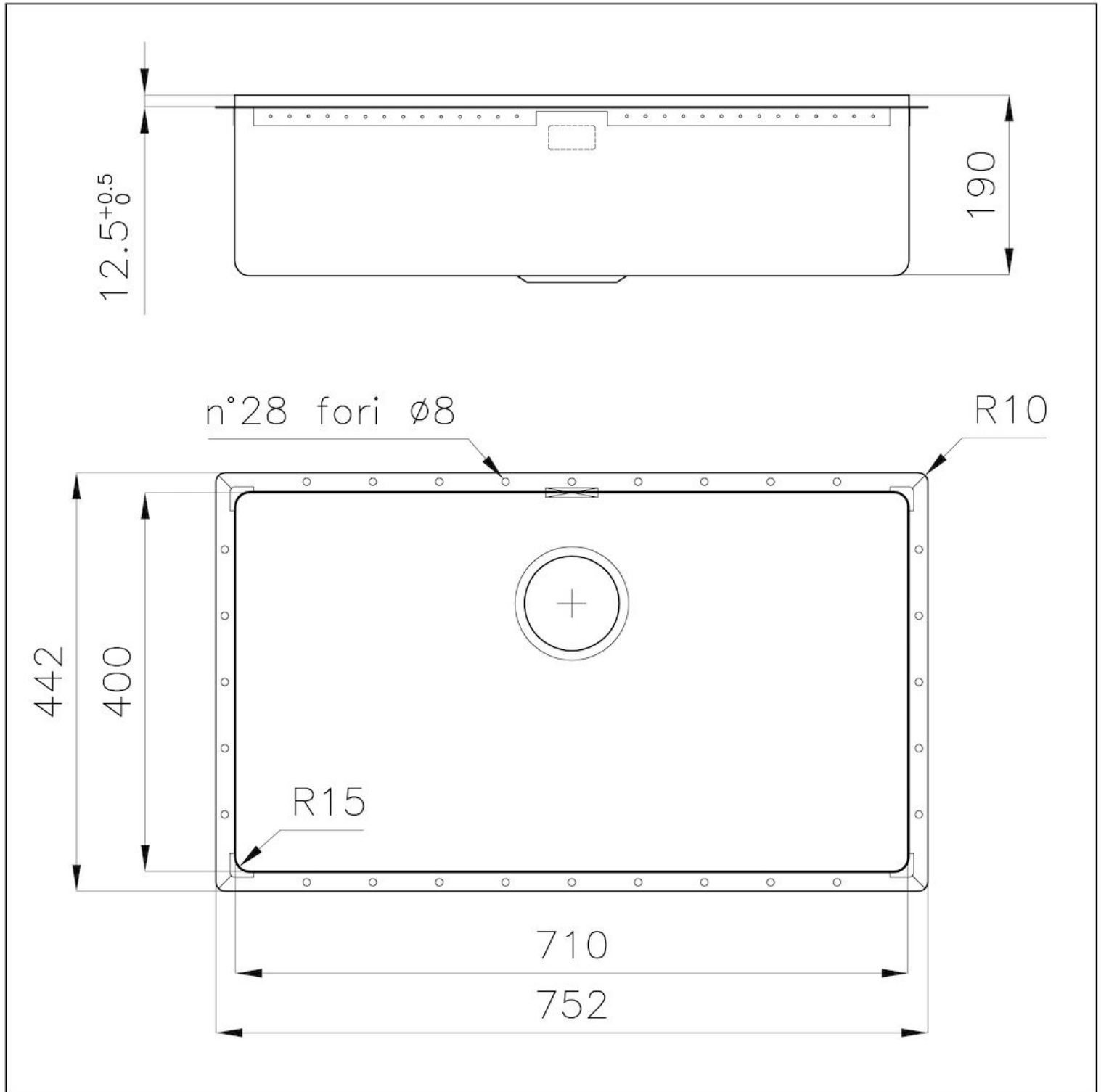





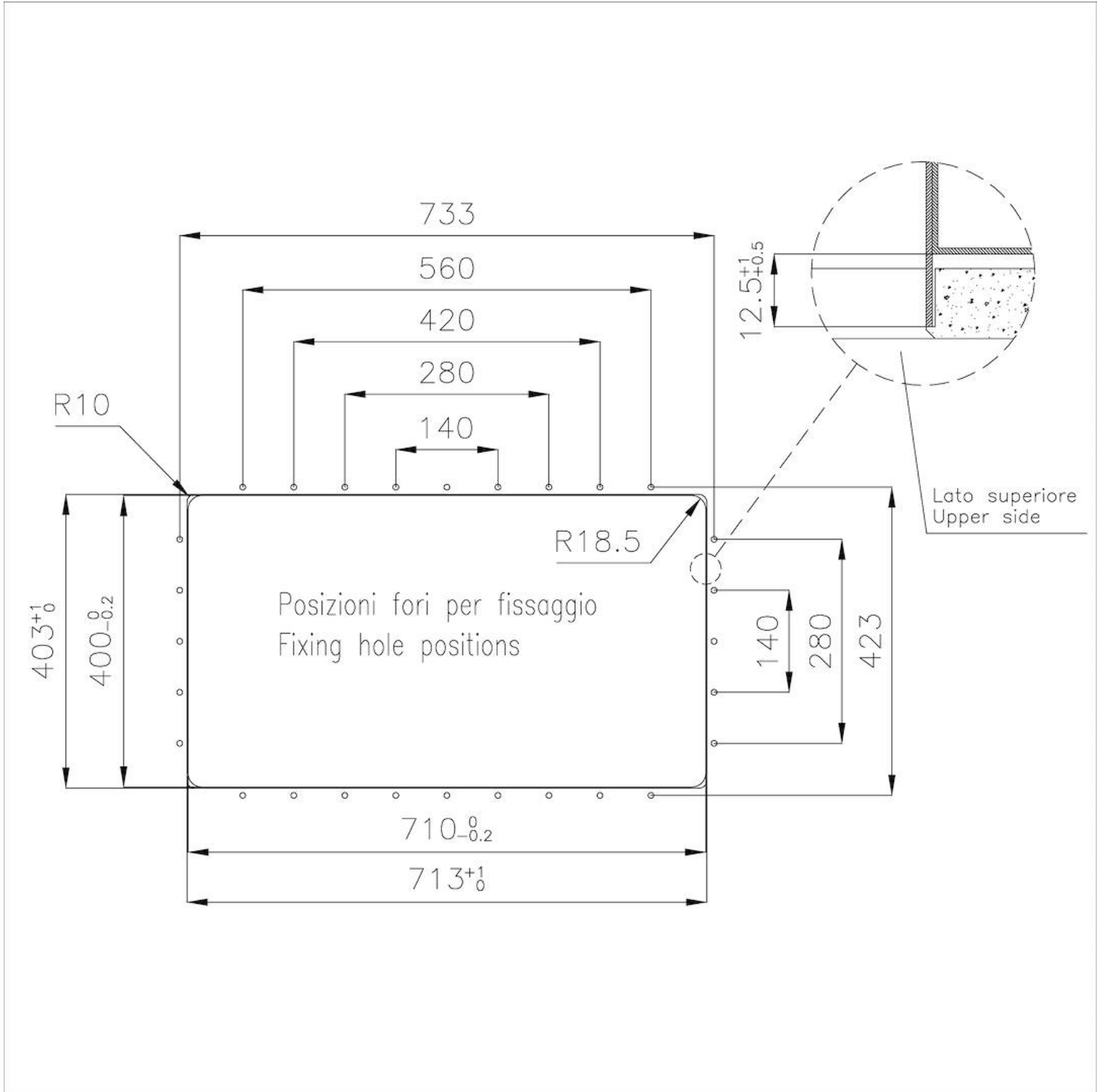

## GALLERY

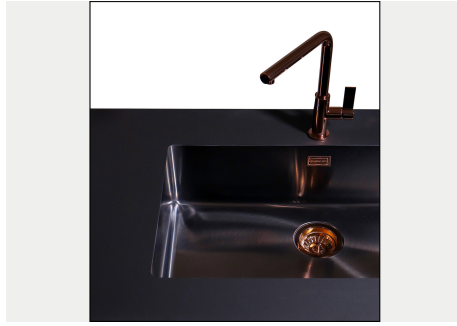

## OPTIONAL ACCESSORIES



HPDE Twin chopping board

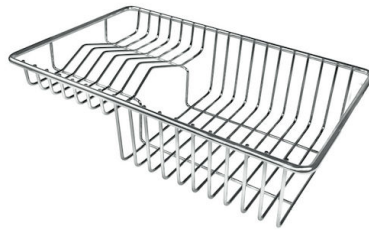

Stainless steel plate rack



Glass chopping board



Graters kit with ring-holder and food collection tray



HPDE Chopping board



Iroko-wood chopping board with stainless steel colander



Iroko-wood sliding chopping board



Iroko-wood twin chopping board



Stainless steel colander



Stainless steel perforated tray



Stainless steel plate rack

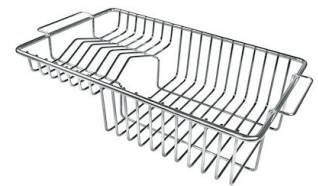

Stainless steel plate rack



White basket



White bowl

**WARNING:**

The accessories 8159101, 8100303, 8151000 are only usable in combination with 8644101



## RECOMMENDED PAIRINGS



Mixer Tap FL



Mixer Tap Omega



Mixer Tap Omega Gun Metal



Mixer Tap Omega Plus



Mixer Tap Omega Plus Gun Metal

## OPTIONAL AUTOMATIC WASTE FITTINGS



Automatic waste fitting



Gun Metal automatic waste fitting