

Top Inox FL

Rangetop and Top inox

Code: 3589 002



DETAILS

Material AISI 304 stainless steel

Texture Brushed in line

Dimensions 2400x600 mm

Full description Top stainless FL - 2400x600 - thickness 20 mm

Heating element Five burners

Mixer holes 2 standard holes

Drainer No

Grids Cast iron grids and enamelled burner covers

Bowl dimension 720x320mm

Number of bowls 1 bowl

Waste fitting Drain with automatic PM control

Total power 10.500 W

Auxiliary 2x1.000 W

Semirapid 2x1.750 W

Dual 5.000 W

Safety Safety valve with quick-acting thermocouple

Ignition Electric ignition under knob

Gas type Tested for installation with natural gas, LPG nozzle set included.

Type Gas Hob

TECHNICAL DATA

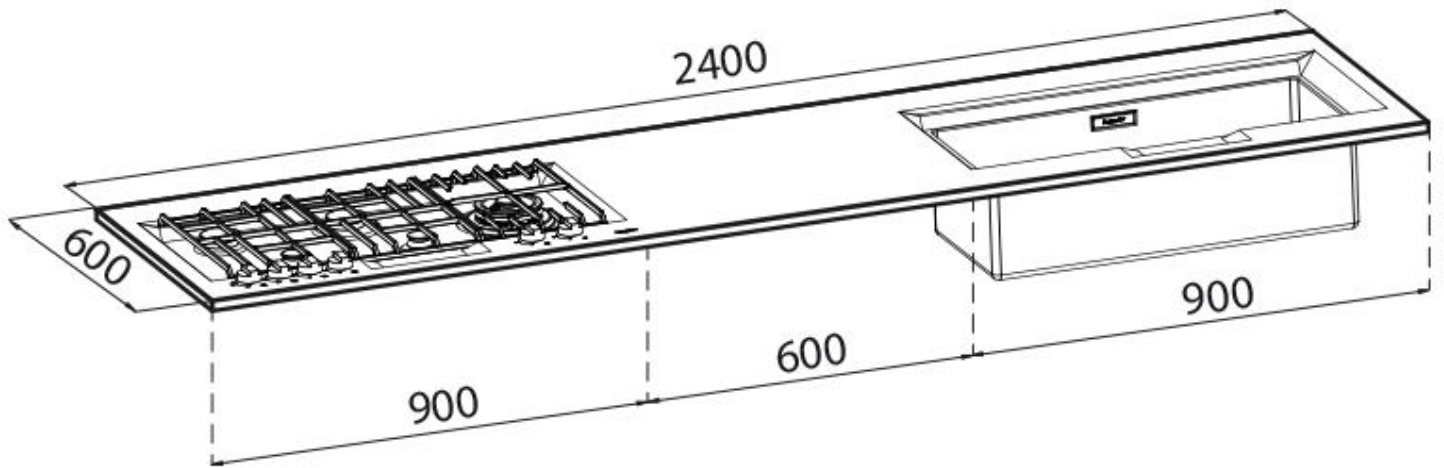

GALLERY



OPTIONAL ACCESSORIES



_telescopic chimney kit



Casper