

Slim equipped troughs

Equipped troughs

Code: 3025 881



DETAILS

Edge/Installation Type	Undermount
Material	AISI 304 stainless steel
Finish	Foster brushed
Texture	Brushed in line
Base	90 cm
External dimensions	846 x 120 mm
Internal dimensions	830 x 72 mm
Width	84,6 cm
Length	3 unit - Slim

Built-in hole

[View technical data sheet](#)

Standard fittings

Fixing hooks, drain, boxed packing

Waste fitting

1¼" drain

Key to understanding the accessories

The lengths of the channels and accessories are indicated in “units”; for the composition, the sum of the “units” of the accessories must be the same as the length in “units” of the channel.

TECHNICAL DATA

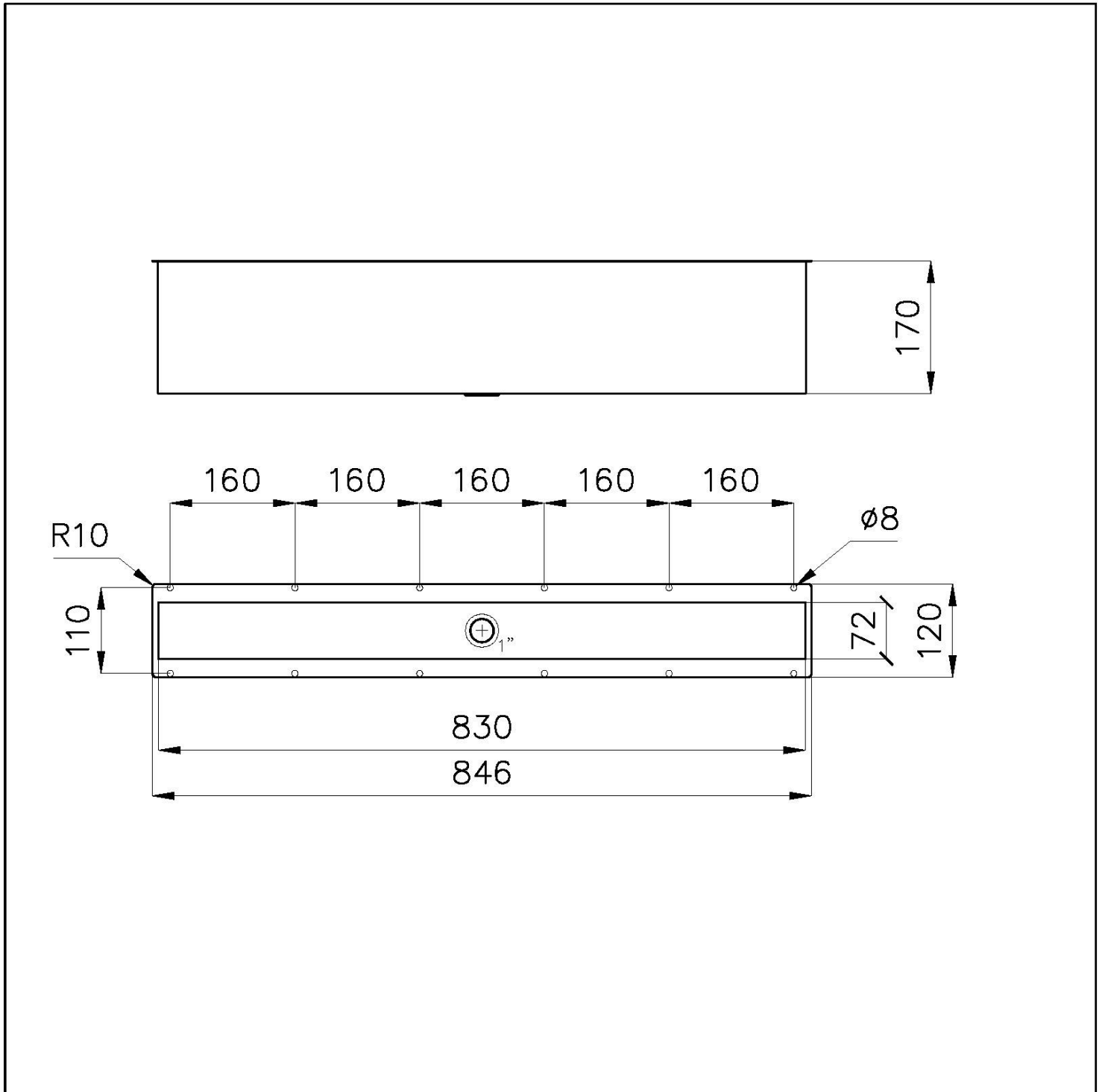

Sottotop/Undermount

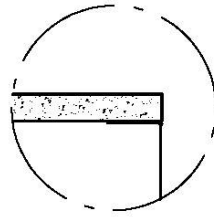

B-B:
Dettaglio installazione
Installation detail

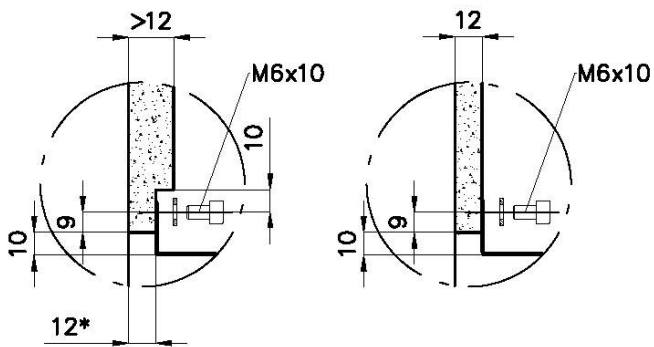

A-A:
Dettaglio installazione positive reveal e sistema di fissaggio
Installation detail with positive reveal and fixing system

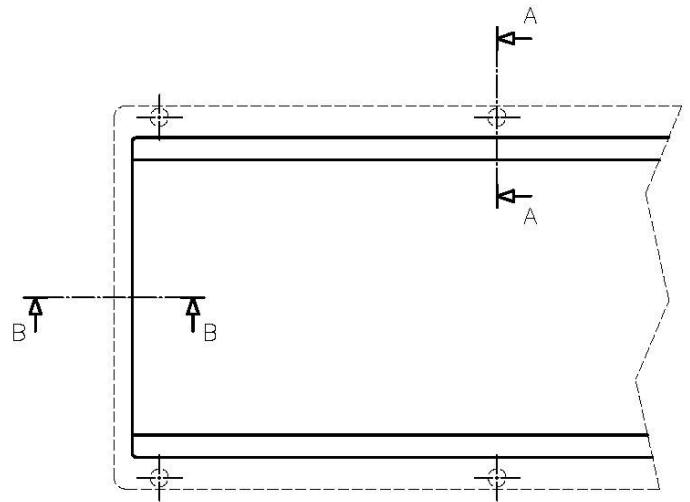

*spessore consigliato per un abbinamento perfetto con gli accessori
*recommended thickness for a perfect match with the accessories

Dimensioni per foratura top
Cut out size

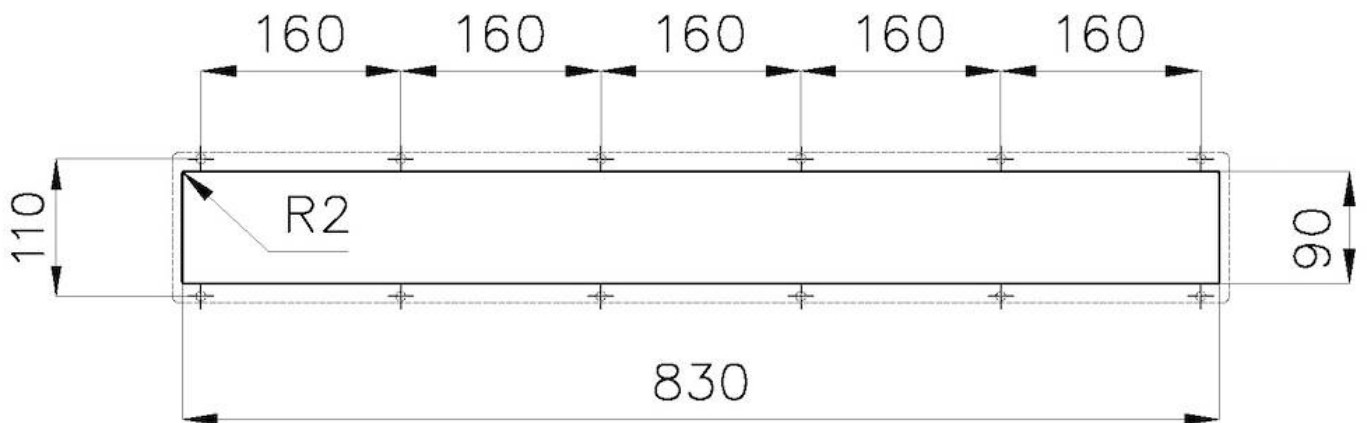

GALLERY



OPTIONAL ACCESSORIES



Kit "I"
8100 707



Kit "L"
8100 708



Kit "M"
8100 709



Kit "O"
8100 715



Stainless steel perforated tray
8151 004