

Hood New Wing



Hoods

Code: 2512 072

75 cm



DETAILS

Material Stainless steel + glass

Texture Brushed in line

Hood type Built-in suction hood

Energy class A

Product details Undercabinet

Operation Suction hood (filtering mode with optional carbon filters)

Suction speed 4 operating speeds

Air exhaust hole \varnothing 150 mm

Motor power 210W

Air flow rate 620mc/h

Lighting Illuminazione 2 LED (4.000 kelvin)

Type of commands Smart rotary control

Notes: Fume exhaust ducts must have an internal diameter not lower than 120 mm

FEATURES

Hood distance 50 cm This hood is approved to be inserted even at a much lower than normal distance from the floor, up to 50 cm, all to the benefit of his suction efficiency.

Led lighting Particular attention to energy saving with LED lighting systems. They assure a 10 times lower consumption and a 10 times longer duration. Our LED lights are designed to create an adequate comfort and safety in the cooking area.

TECHNICAL DATA

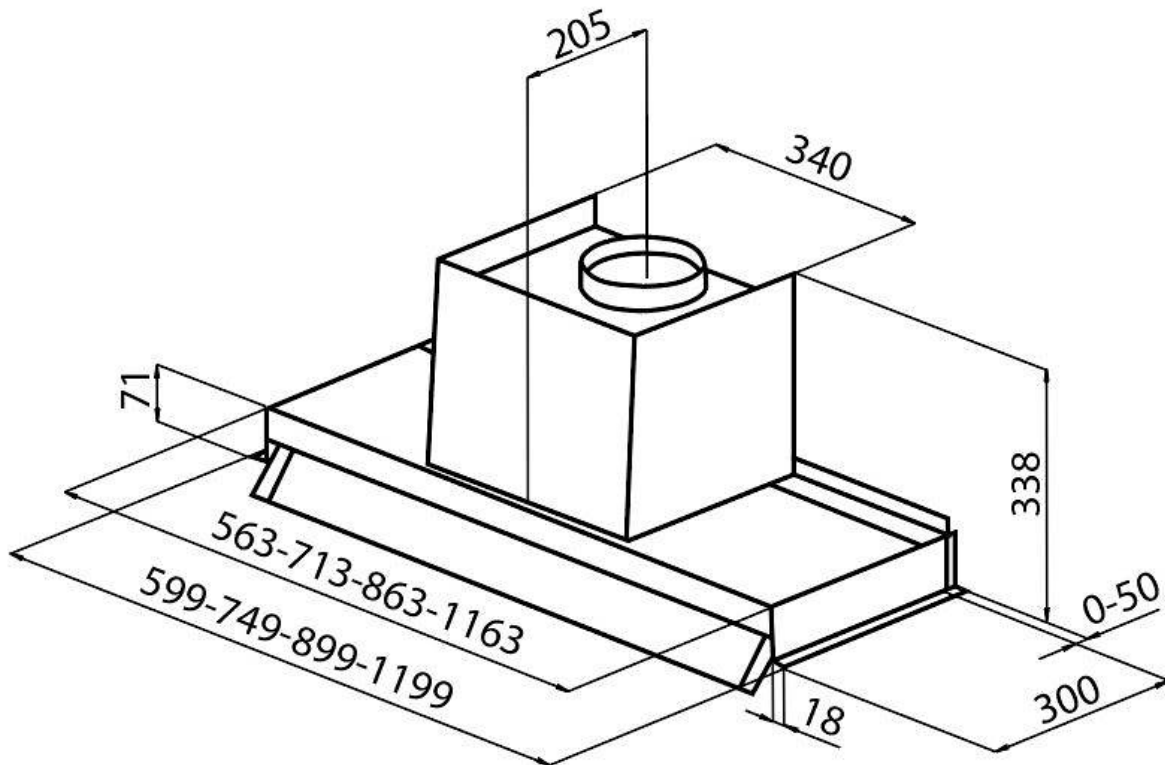

GALLERY

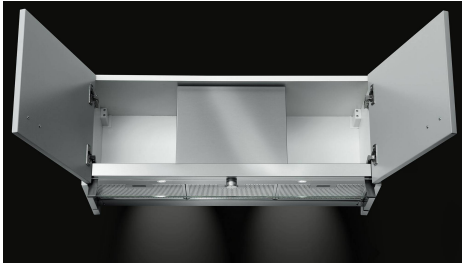

OPTIONAL ACCESSORIES



Carbon filters kit
9700 221



Flexible silencing canalization
9700 602



Flexible silencing canalization
9700 603

RECOMMENDED PAIRINGS



Sink S4001
3138 850



Cooker hob KE
7602 032

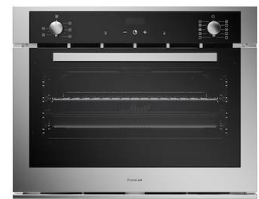

Oven KE 75
7137 000