

Hood Ghost 120 Filotop

Hoods

Code: 2451 120



DETAILS

Coloring Black

Material Stainless steel + glass

Texture Brushed in line

Height from floor 300mm

Energy class A

Product details Filotop inserting

Dimensions on plane 1175x120mm

Grease filters 2 grease adonized aluminium filtre

Operation Suction hood (filtering mode with optional carbon filters)

Cut out	1142x100 mm
Air exhaust hole	ø 120/150 mm
Lighting	Illuminazione LED Strip (9W - 4.200 kelvin)
Notes:	The motor can be positioned frontally, on the back of the hood and in remote mode with the appropriate optional kit.
Air flow rate	800mc/h
Motor power	275W
Hood type	Table-top hood
Type of commands	Touch Control
Suction speed	4 operating speeds
Notes:	Fume exhaust ducts must have an internal diameter not lower than 120 mm

FEATURES

Auto delayed shutdown	All the models with electronic interface can be programmed to turn off the suction at a postponed moment, so as to prolong the aeration of the room even after the cooking has been completed.
Filter cleaning notice	This function keeps track of the hours of use of the hood and signals the need to wash the filters in order to maintain the perfect efficiency of the hood.

Led lighting

Particular attention to energy saving with LED lighting systems. They assure a 10 times lower consumption and a 10 times longer duration. Our LED lights are designed to create an adequate comfort and safety in the cooking area.

TECHNICAL DATA

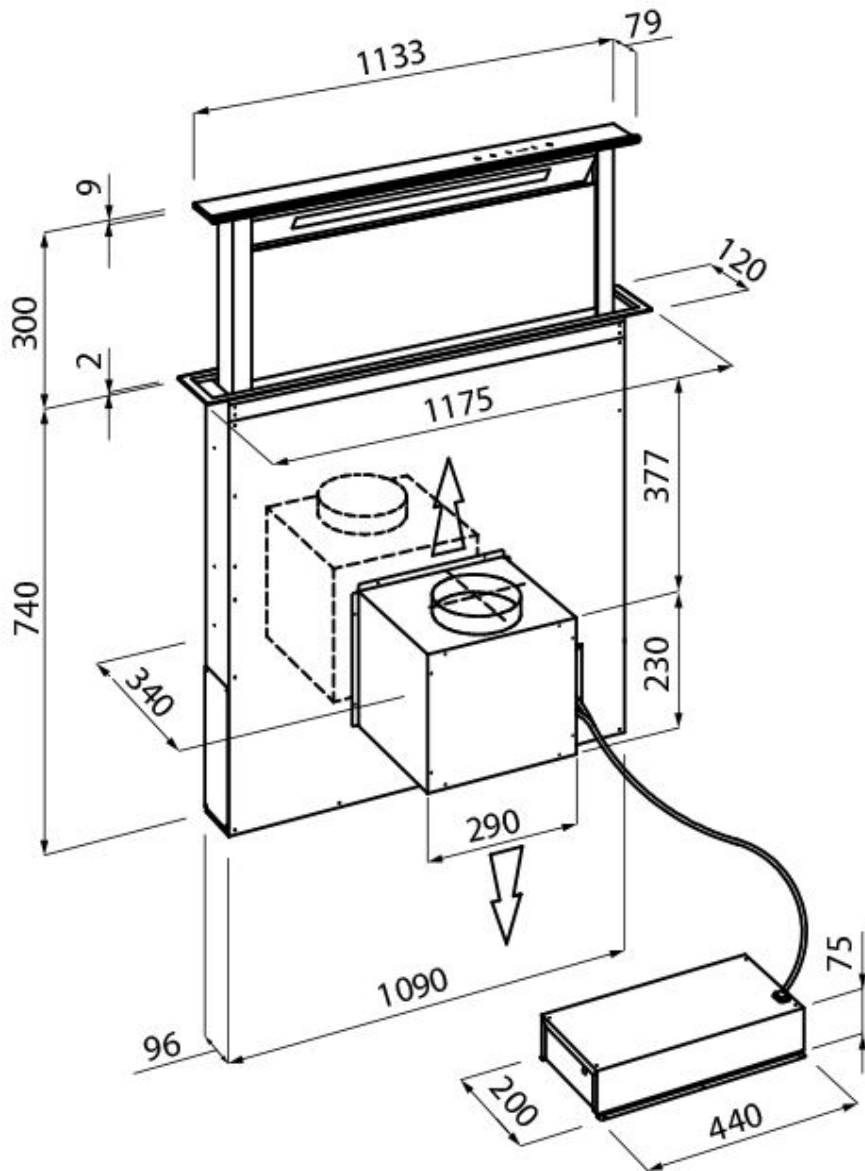

GALLERY

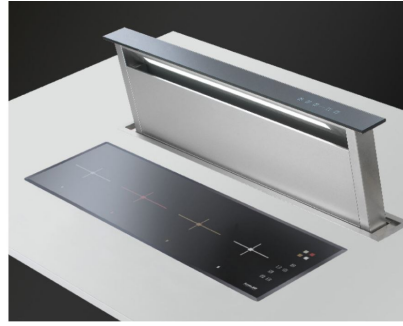
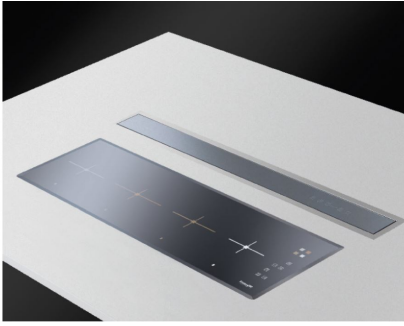

OPTIONAL ACCESSORIES



Carbon filters kit
9700 460

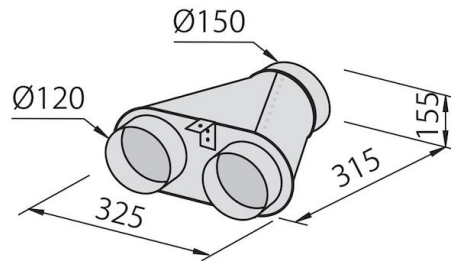

Collector for 2 pipes
2523 000

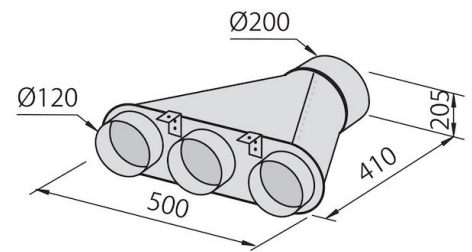

Collector for 3 pipes
2524 000

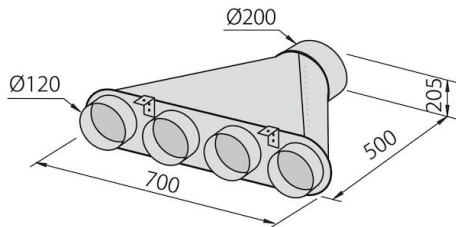

Collector for 4 pipes
2525 000



Flexible silencing canalization
9700 602



Flexible silencing canalization
9700 603

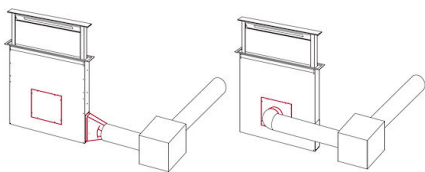

Remote engine installation kit
9700 459

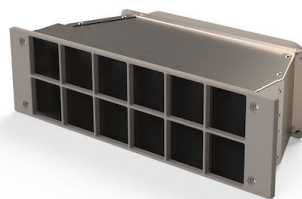

Carbon filter
9700 574