

## Hood S4001 wall



Hoods

Code: 2440 091

90 cm



### DETAILS

Material AISI 304 stainless steel

---

Texture Brushed in line

---

Chimney height 630 - 1050 mm

---

Energy class A+

---

Product details Telescopic chimney

---

Grease filters 2 grease filters

---

Operation Suction hood (filtering mode with optional carbon filters)

---

Air exhaust hole  $\varnothing$  120/150 mm

---

Lighting LED lighting: 6 x 1W (5.600 kelvin)

---

Air flow rate 700mc/h

---

Motor power 160W

---

Hood type Wall-mounted suction hood

---

Type of commands Minimal electronic controls

---

Suction speed 4 operating speeds

---

Notes: Fume exhaust ducts must have an internal diameter not lower than 120 mm

---

## FEATURES

**Auto delayed shutdown** All the models with electronic interface can be programmed to turn off the suction at a postponed moment, so as to prolong the aeration of the room even after the cooking has been completed.

---

**Brushless motor** State-of-the-art Brushless motors allow high air flow rates while maintaining a low energy consumption. Furthermore, they have an almost never-ending duration.

---

**high performance** Foster hoods motors have a high suction capacity. Their refined design hides a powerful appliance with professional features.

---

**Led lighting** Particular attention to energy saving with LED lighting systems. They assure a 10 times lower consumption and a 10 times longer duration. Our LED lights are designed to create an adequate comfort and safety in the cooking area.

---

**Perimetric aspiration** The perimeter suction is a feature common to many Foster hoods. The filters are hidden by steel- or crystal plates and the suction occurs along their perimeter. This has aesthetic advantages but also functional ones: the cleaning is easier, the suction power and noise-level are improved. The depression which occurs in the perimeter area facilitates in fact the suction of the particles composing the fumes.

---

## TECHNICAL DATA

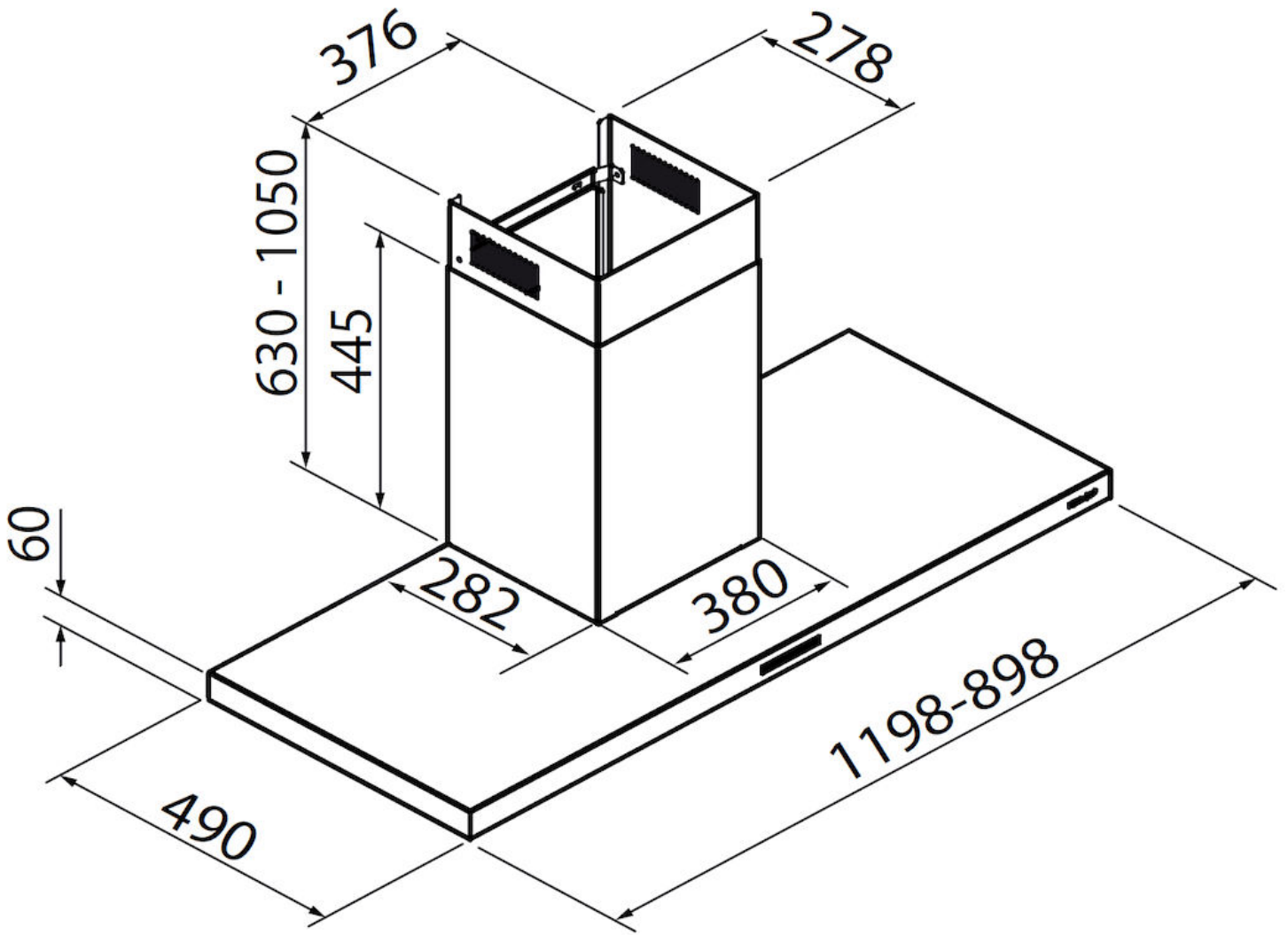

## GALLERY



## OPTIONAL ACCESSORIES

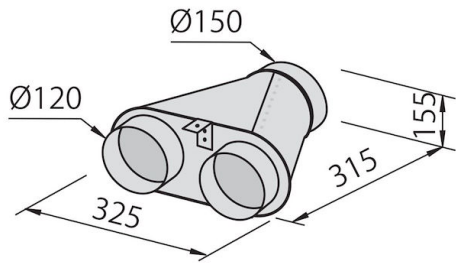

**Collector for 2 pipes**  
2523 000

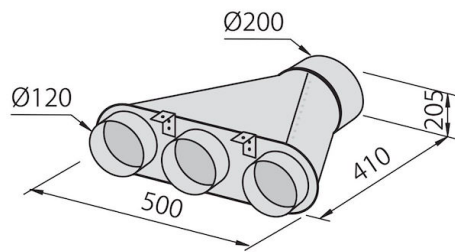

**Collector for 3 pipes**  
2524 000

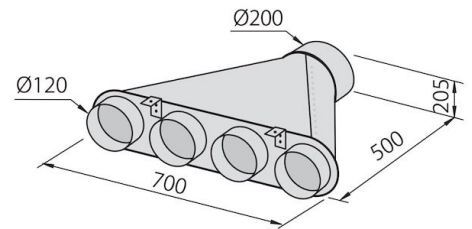

**Collector for 4 pipes**  
2525 000



**Flexible silencing canalization**  
9700 602



**Flexible silencing canalization**  
9700 603



**Long Life carbon filter**  
9700 001