

Sink KE Filotop Gun Metal

Kitchen Sinks

Code: 2154 056



DETAILS

Coloring Gun Metal

Edge/Installation Type Flush-mount | Top-mount

Finish PVD

Material AISI 304 stainless steel

Texture Foster brushed

Base 60 cm

Dimensions 490x440 mm

Standard fittings Fixing hooks, gasket, drain, overflow and siphon, boxed packing

Mixer holes No standard holes

Built-in hole [View technical data sheet](#)

Drainer No

Width 49 cm

Bowl dimension 450x400mm

Number of bowls 1 bowl

Waste fitting 3,5" drain

FEATURES

Basket 3,5" waste fitting The drain is equipped with a large 3.5" drain, with the practical basket cap that prevents the discharge of solid parts.

Gun Metal The Gun Metal finish is obtained by treating steel with a physical process called PVD (Physical Vacuum Deposition) which deposits particles of noble metals on the surface. The result is a unique and refined aesthetic effect, and an improvement of the mechanical properties of the steel which is more resistant to impact and scratches.

High thickness 1mm thick steel. A significant thickness, which guarantees the maximum sturdiness and durability.

Perimetral overflow The overflow is always a security on the Foster sinks that prevents the overflow of water in case of oversights. The perimeter drain solution improves aesthetics thanks to its square and essential shape.

Small radius Bowls with squared shapes with a modern design and an increased capacity, for a minimal aesthetics connected with an extreme practicality.

TECHNICAL DATA

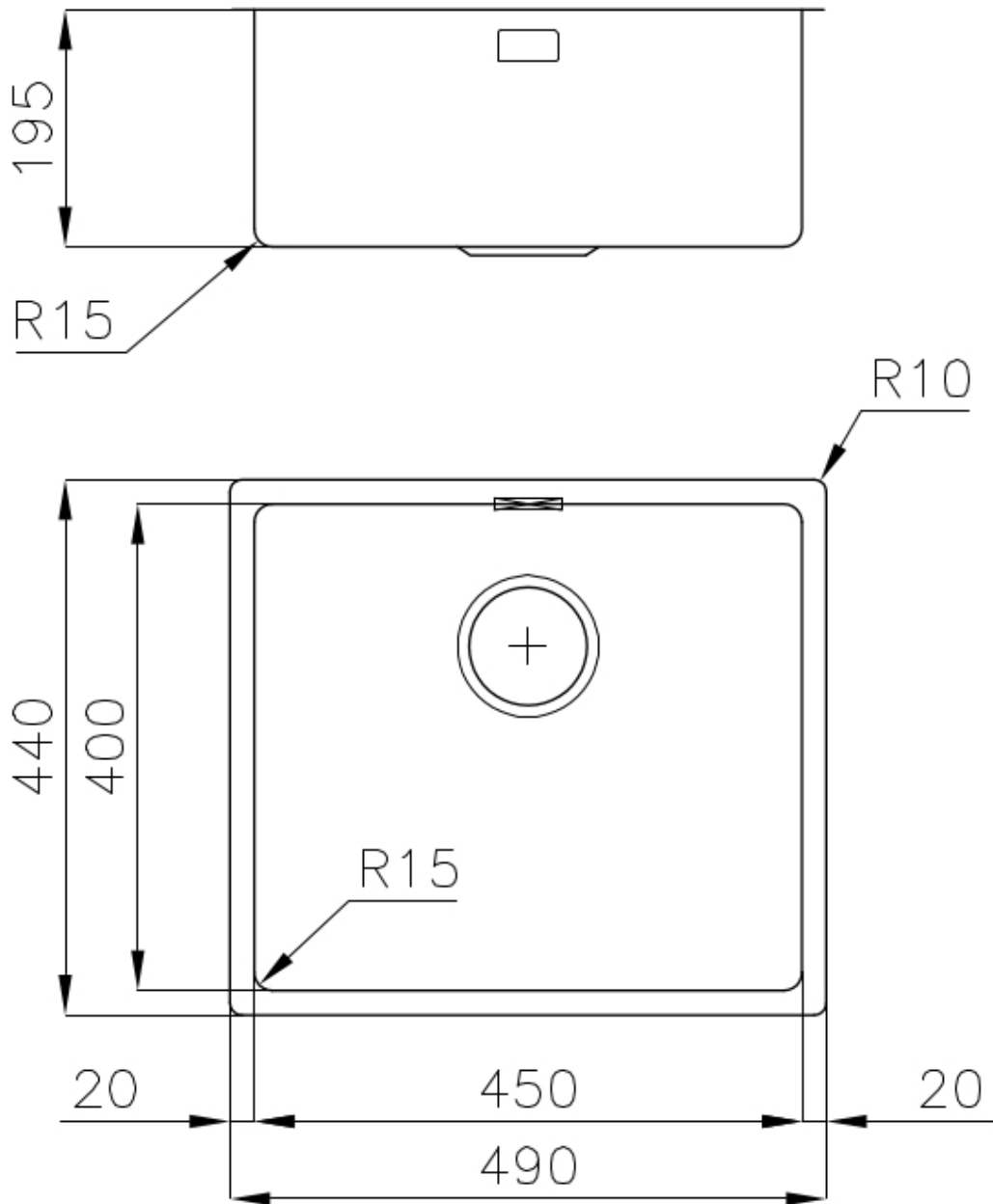

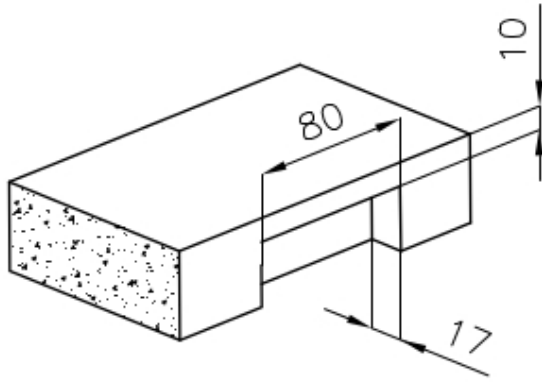

Intaglio per il troppo-pieno
Recess for housing the over-flow

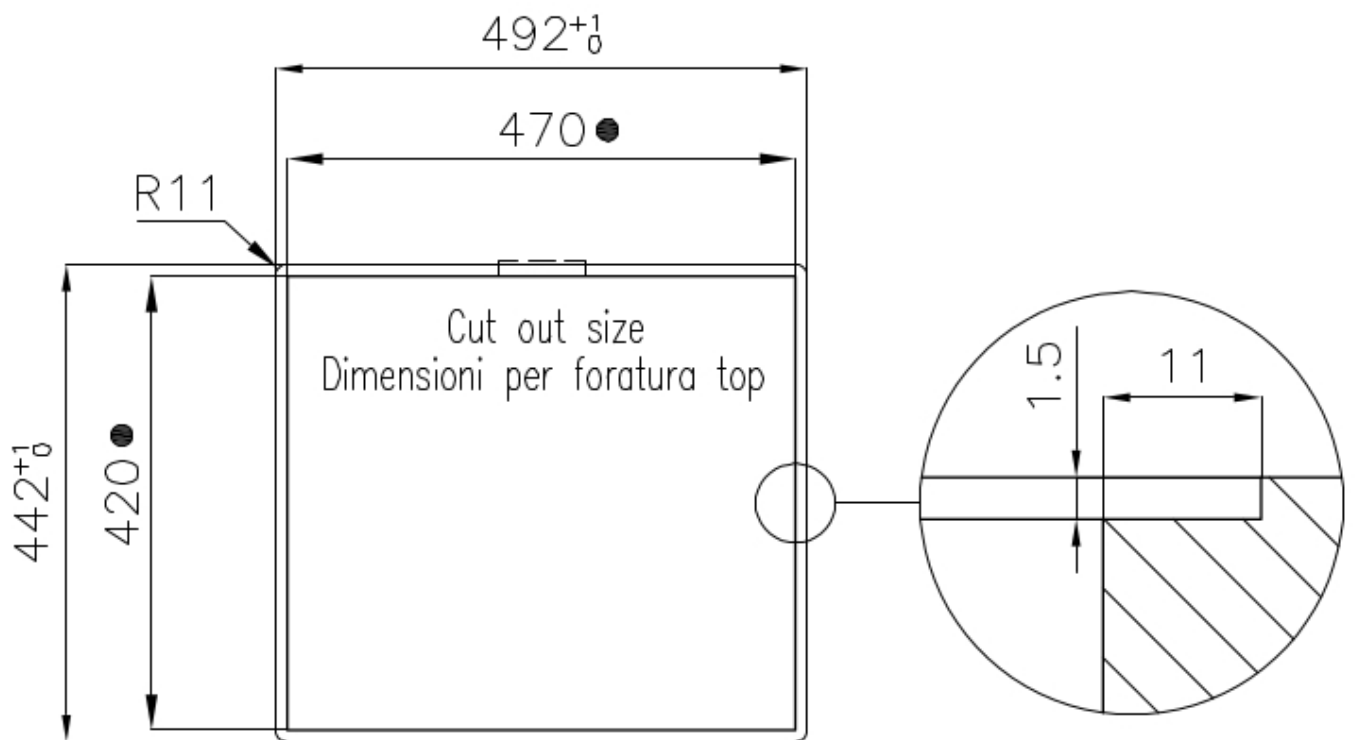

- Built-in cut out for FTS – Foratura per installazione FTS

GALLERY

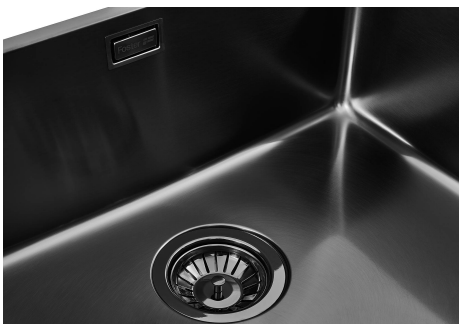

OPTIONAL ACCESSORIES



Glass chopping board
8631 300



HDPE Chopping board
8657 001



HPDE Twin chopping board
8644 101



Stainless steel plate rack
8100 303
* only in combination with the accessory
8644 101

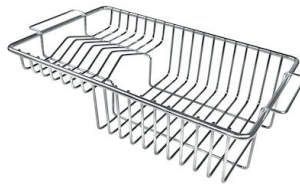

Stainless steel plate rack
8100 201



White bowl
8153 100



Black grid
8100 617



**Graters kit with ring-holder and
food collection tray**
8159 101
* only in combination with the accessory
8644 101



**Iroko-wood sliding chopping board
with stainless steel colander**
8644 044



Stainless steel perforated tray

8151 000

* only in combination with the accessory
8644 101



**Stainless steel perforated tray PVD
Gun Metal**

8151 006

* only in combination with the accessory
8644 101

RECOMMENDED PAIRINGS



Mixer Tap Bert

8428 100



Mixer Tap KE

8492 000

OPTIONAL AUTOMATIC WASTE FITTINGS



**Gun Metal automatic waste fitting -
PG**

8407 110