

Sink Quadra R12

Kitchen Sinks

Code: 1718 850

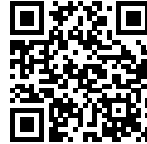

DETAILS

Material AISI 304 stainless steel

Texture Brushed in line

Finish Foster brushed

Edge/Installation Type Undermount

Base 90 cm

Dimensions 840 x 440 mm

Bowl dimension 800 x 400 mm

Width 84 cm

Built-in hole [View technical data sheet](#)

Number of bowls	1 bowl
Standard fittings	Fixing hooks, drain, overflow and siphon, boxed packing
Drainer	No
Mixer holes	No standard holes
Waste fitting	Drain SPACE 3,5"

FEATURES

Deep bowls	This bowls reach an important depth, over 20 cm, thanks to the advanced production technology, that can be offer great capiciency and practicity in all the washing operations.
Diamond-shape bottom	The draining of water is an important feature in a sink, and it's always taken good care of in Foster products. In the bent-welded sinks, which would have a flat bottom, the proper draining is guaranteed by the elegant beveling, which helps the water flow.
High thickness	1mm thick steel. A significant thickness, which guarantees the maximum sturdiness and durability.
Perimetral overflow	The overflow is always a security on the Foster sinks that prevents the overflow of water in case of oversights. The perimeter drain solution improves aesthetics thanks to its square and essential shape.
Small radius	Bowls with squared shapes with a modern design and an increased capacity, for a minimal aesthetics connected with an extreme practicity.

TECHNICAL DATA

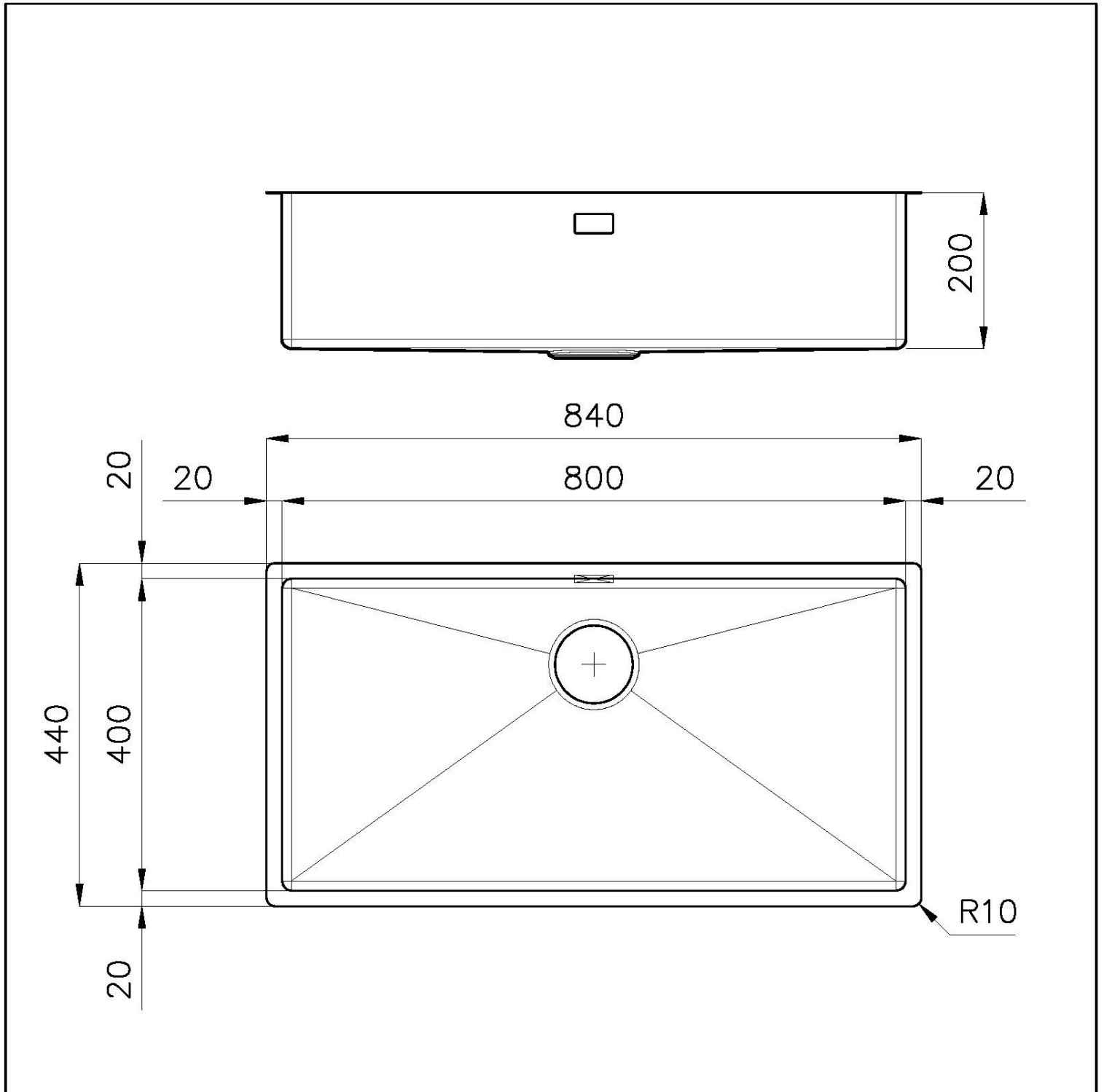

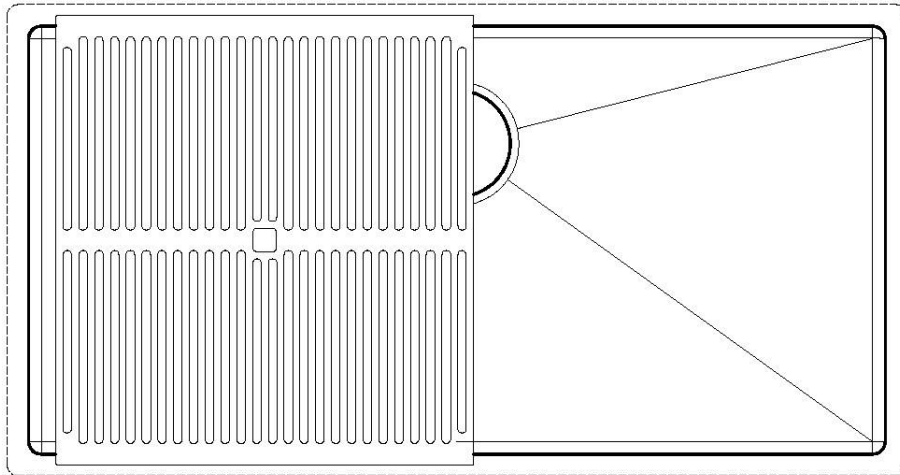

8100 617
POSIZIONATA A FILO VASCA / EDGE POSITIONING

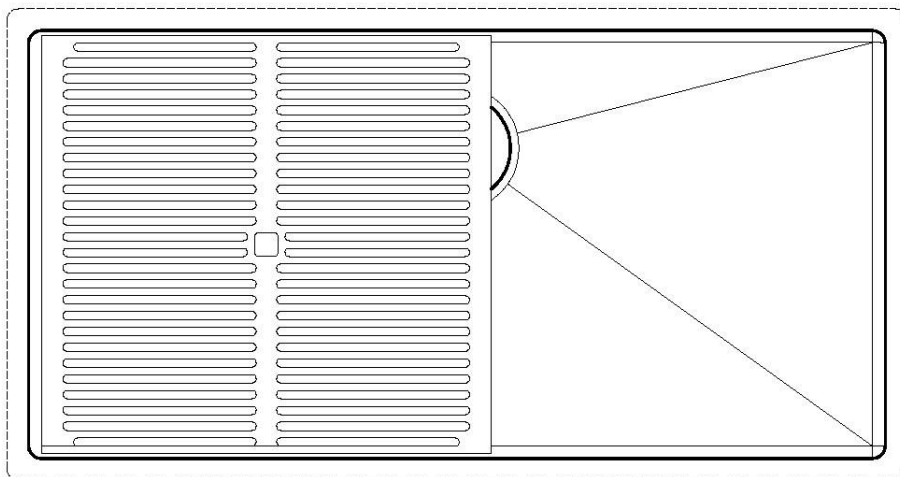

8100 617
POSIZIONATA SUL FONDO / BOTTOM POSITIONING

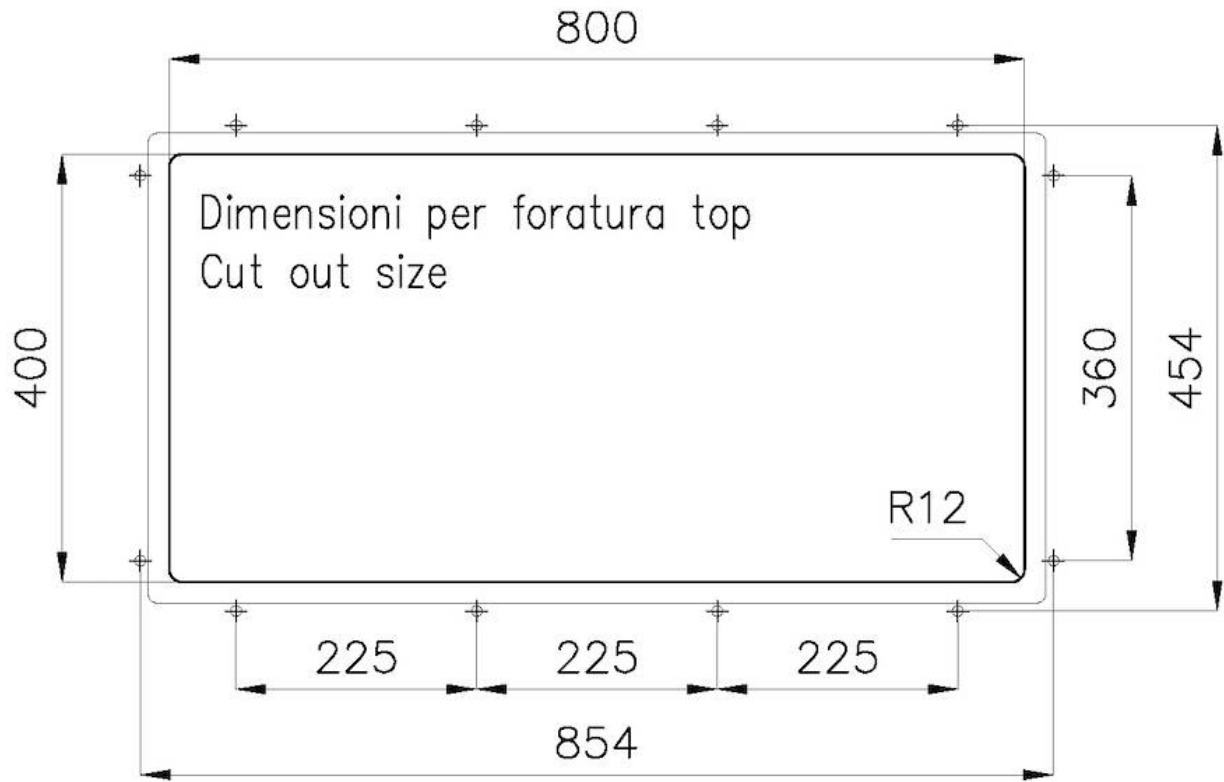

GALLERY



EQUIPMENT



Black grid
8100 617

OPTIONAL ACCESSORIES



Glass chopping board
8631 300



Graters kit with ring-holder and food collection tray
8159 101
* only in combination with the accessory 8644 101



HDPE Chopping board
8657 001



HDPE Twin chopping board
8644 101



Iroko-wood sliding chopping board with stainless steel colander
8644 044



Stainless steel perforated tray
8151 000
* only in combination with the accessory 8644 101



Stainless steel perforated tray PVD Copper
8151 008
* only in combination with the accessory 8644 101



Stainless steel perforated tray PVD Gold
8151 009
* only in combination with the accessory 8644 101



Stainless steel perforated tray PVD Gun Metal
8151 006
* only in combination with the accessory 8644 101

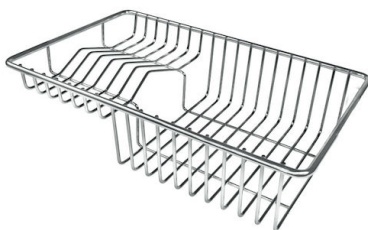

Stainless steel plate rack
8100 303
* only in combination with the accessory 8644 101



Stainless steel plate rack
8100 201



White bowl
8153 100

RECOMMENDED PAIRINGS



Cooker hob KE
7602 032

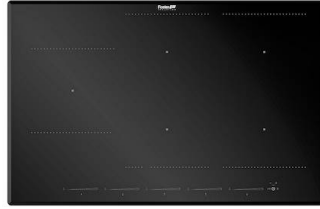

Cooker hob KE Induction
7386 646



Mixer Tap Omega Plus
8497 020

OPTIONAL AUTOMATIC WASTE FITTINGS



Automatic waste fitting - PM
8407 113



Space automatic waste fitting - PA
8407 108



Space automatic waste fitting - PE
8407 109



**Space Light automatic waste fitting
- PL**
8407 117



**Space Push automatic waste fitting
- PP**
8407 116