

Sink Quadra R12 Gun Metal Fumè

Kitchen Sinks

Code: 1715 816

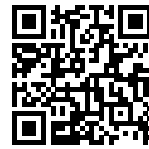

DETAILS

Material AISI 304 stainless steel

Finish PVD

Coloring Gun Metal

Texture Fumé

Edge/Installation Type Undermount

Base 60 cm

Dimensions 540 x 440 mm

Bowl dimension 500 x 400 mm

Width 54 cm

Built-in hole

[View technical data sheet](#)

Number of bowls

1 bowl

Standard fittings

Fixing hooks, drain, overflow and siphon, boxed packing

Drainer

No

Mixer holes

No standard holes

Waste fitting

Drain SPACE 3,5"

FEATURES

Deep bowls

This bowls reach an important depth, over 20 cm, thanks to the advanced production technology, that can be offer great capieny and practicity in all the washing operations.

Diamond-shape bottom

The draining of water is an important feature in a sink, and it's always taken good care of in Foster products. In the bent-welded sinks, which would have a flat bottom, the proper draining is guaranteed by the elegant beveling, which helps the water flow.

GUN METAL FUMÈ

The Gun Metal Fumè finish is obtained by treating steel with a physical process called PVD (Phisical Vacuum Deposition) which deposits particles of noble metals on the surface. The result is a unique and refined aesthetic effect, and an improvement of the mechanical properties of the steel which is more resistant to impact and scratches.

High thickness

1mm thick steel. A significant thickness, which guarantees the maximum sturdiness and durability.

Perimetral overflow

The overflow is always a security on the Foster sinks that prevents the overflow of water in case of oversights. The perimeter drain solution improves aesthetics thanks to its square and essential shape.

Small radius

Bowls with squared shapes with a modern design and an increased capacity, for a minimal aesthetics connected with an extreme practicity.

TECHNICAL DATA

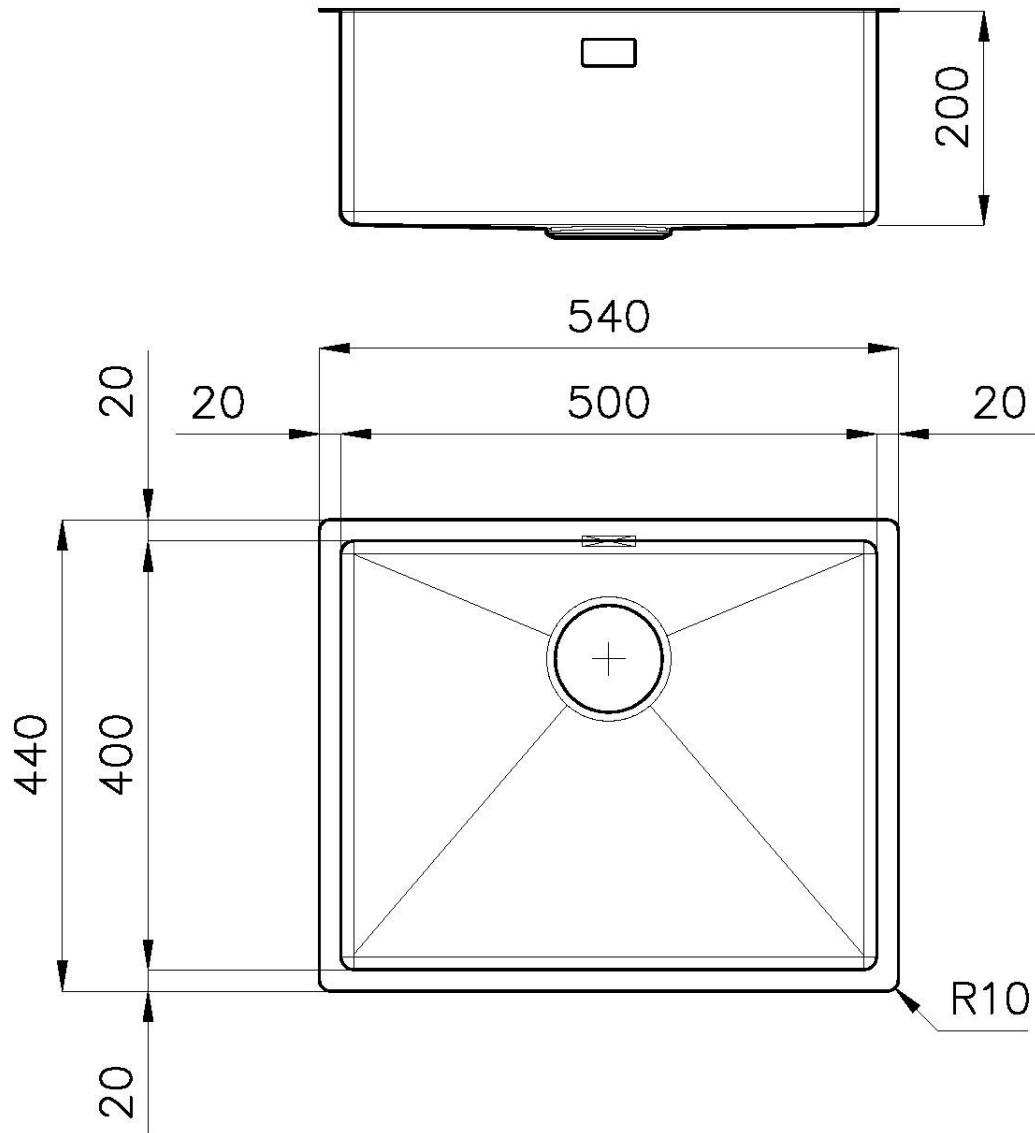

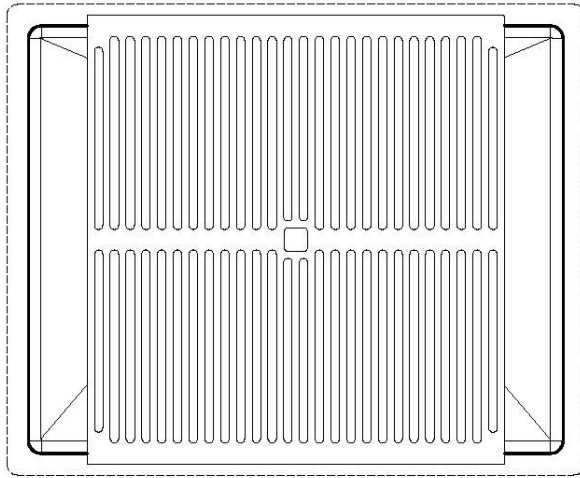

8100 617
POSIZIONATA A FILO VASCA / EDGE POSITIONING

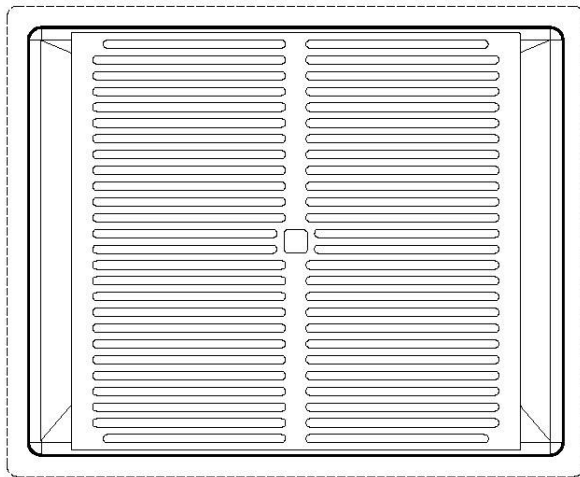

8100 617
POSIZIONATA SUL FONDO / BOTTOM POSITIONING



GALLERY



EQUIPMENT



Black grid
8100 617

OPTIONAL ACCESSORIES



Glass chopping board
8631 300



Graters kit with ring-holder and food collection tray
8159 101
* only in combination with the accessory 8644 101



HDPE Chopping board
8657 001



HDPE Twin chopping board
8644 101



Iroko-wood sliding chopping board with stainless steel colander
8644 044



Stainless steel perforated tray
8151 000
* only in combination with the accessory 8644 101



Stainless steel perforated tray PVD Copper
8151 008
* only in combination with the accessory 8644 101



Stainless steel perforated tray PVD Gold
8151 009
* only in combination with the accessory 8644 101



Stainless steel perforated tray PVD Gun Metal
8151 006
* only in combination with the accessory 8644 101

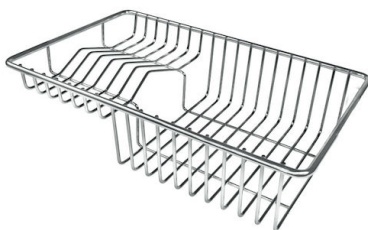

Stainless steel plate rack
8100 303
* only in combination with the accessory 8644 101



Stainless steel plate rack
8100 201



White bowl
8153 100

RECOMMENDED PAIRINGS

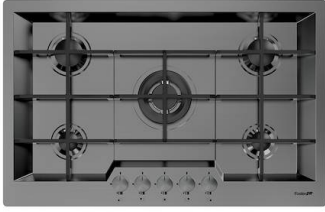

Cooker hob KE Gun Metal
7601 632

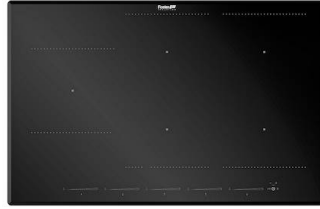

Cooker hob KE Induction
7386 646



Mixer Tap Omega Plus Gun Metal
8498 856

OPTIONAL AUTOMATIC WASTE FITTINGS



**Space Push Gun Metal automatic
waste fitting - PO**
8407 120