

Sink Big Bowl

Kitchen Sinks

Code: 1562 001



DETAILS

Edge/Installation Type Standard (8 mm Edge)

Finish Foster brushed

Material AISI 304 stainless steel

Texture Foster brushed

Base 90 cm

Dimensions 860x500 mm

Standard fittings Fixing hooks, gasket, drain, overflow and siphon, boxed packing

Mixer holes 1 standard hole - 2nd hole on request

Built-in hole 840x480 mm

Drainer No

Width 86 cm

Bowl dimension 450x400 + 275x400mm

Number of bowls 2 bowls

Waste fitting 3,5" drain

FEATURES

2nd / 3rd hole available The sink can be customized with the execution on request of additional holes, usable for double-hole mixers, for remote controlled drains or for the installation of soap dispensers. The positions are marked on the drawings with dotted line holes.

Added value Foster uses steel thicknesses higher than those used on average by other manufacturers. This is how, thanks to our long experience, we know how to make sinks of superior quality and with a better resistance to aging.

Basket 3,5" waste fitting The drain is equipped with a large 3.5" drain, with the practical basket cap that prevents the discharge of solid parts.

Sliding brackets

TECHNICAL DATA

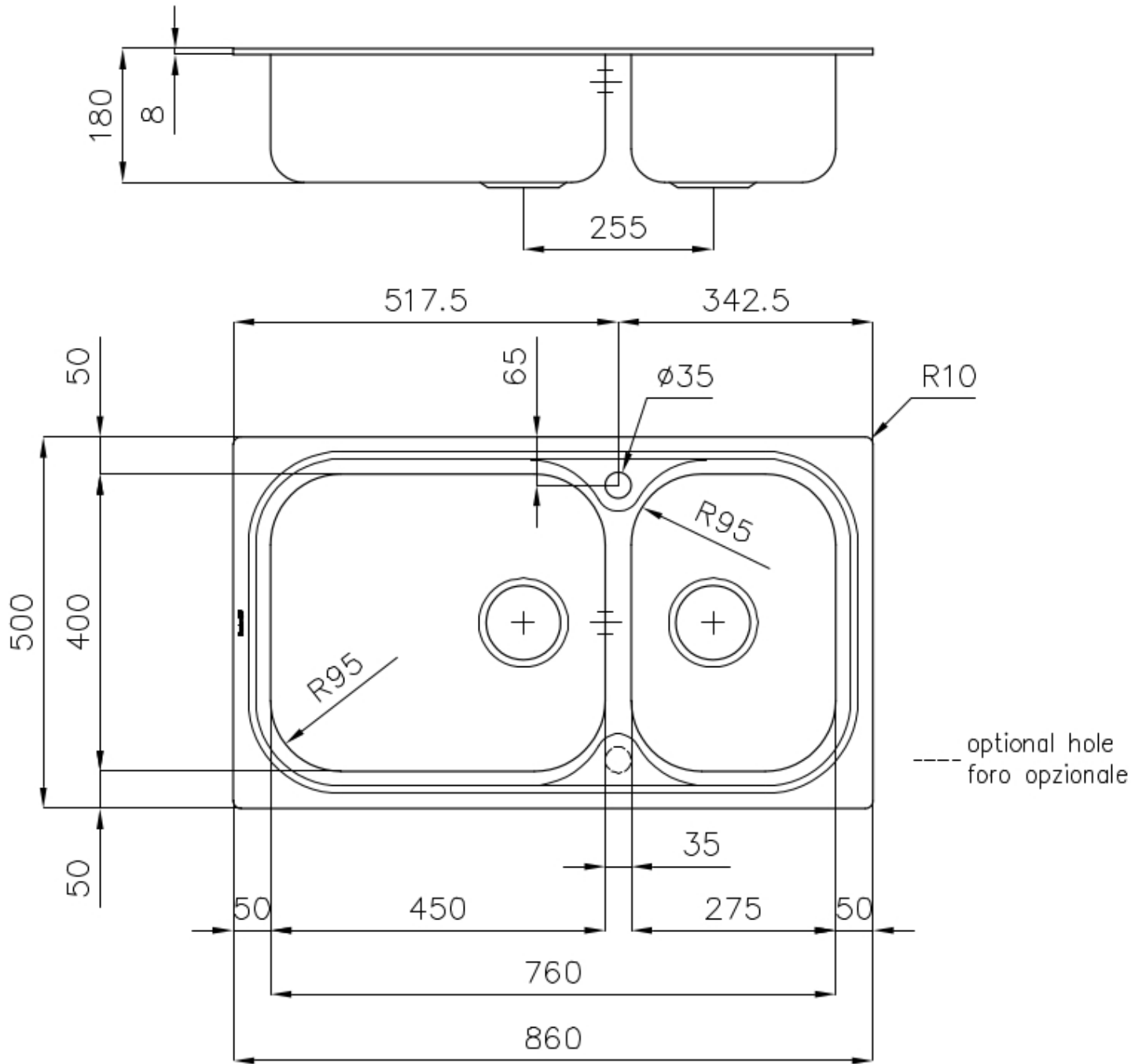

GALLERY



OPTIONAL ACCESSORIES



Cestello inox



Glass chopping board



HPDE Chopping board



Iroko-wood chopping board



Iroko-wood sliding chopping board



Stainless steel plate rack

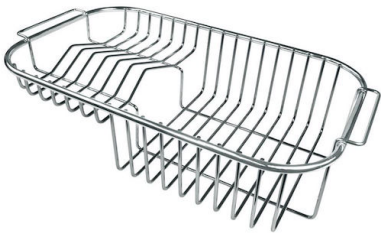

Stainless steel plate rack

RECOMMENDED PAIRINGS



Mixer Tap Delta



Mixer Tap Luisa

OPTIONAL AUTOMATIC WASTE FITTINGS



Automatic waste fitting



Automatic waste fitting



LIRA automatic waste fitting



LIRA automatic waste fitting