

Sink S1000

Kitchen Sinks

Code: 1197 161



DETAILS

Edge/Installation Type Standard (8 mm Edge)

Finish Foster brushed

Material AISI 304 stainless steel

Texture Foster brushed

Base 60-80 cm

Dimensions 970x500 mm

Standard fittings Fixing hooks, gasket, drain, overflow and siphon, boxed packing

Mixer holes 1 standard hole - 2nd hole on request

Built-in hole 950x480 mm

Drainer Yes

Width 97 cm

Bowl dimension 340x400 + 170x340mm

Number of bowls 2 bowls

Waste fitting 3,5" drain

FEATURES

2nd / 3rd hole available The sink can be customized with the execution on request of additional holes, usable for double-hole mixers, for remote controlled drains or for the installation of soap dispensers. The positions are marked on the drawings with dotted line holes.

Added value Foster uses steel thicknesses higher than those used on average by other manufacturers. This is how, thanks to our long experience, we know how to make sinks of superior quality and with a better resistance to aging.

Basket 3,5" waste fitting The drain is equipped with a large 3.5" drain, with the practical basket cap that prevents the discharge of solid parts.

Sliding brackets

TECHNICAL DATA

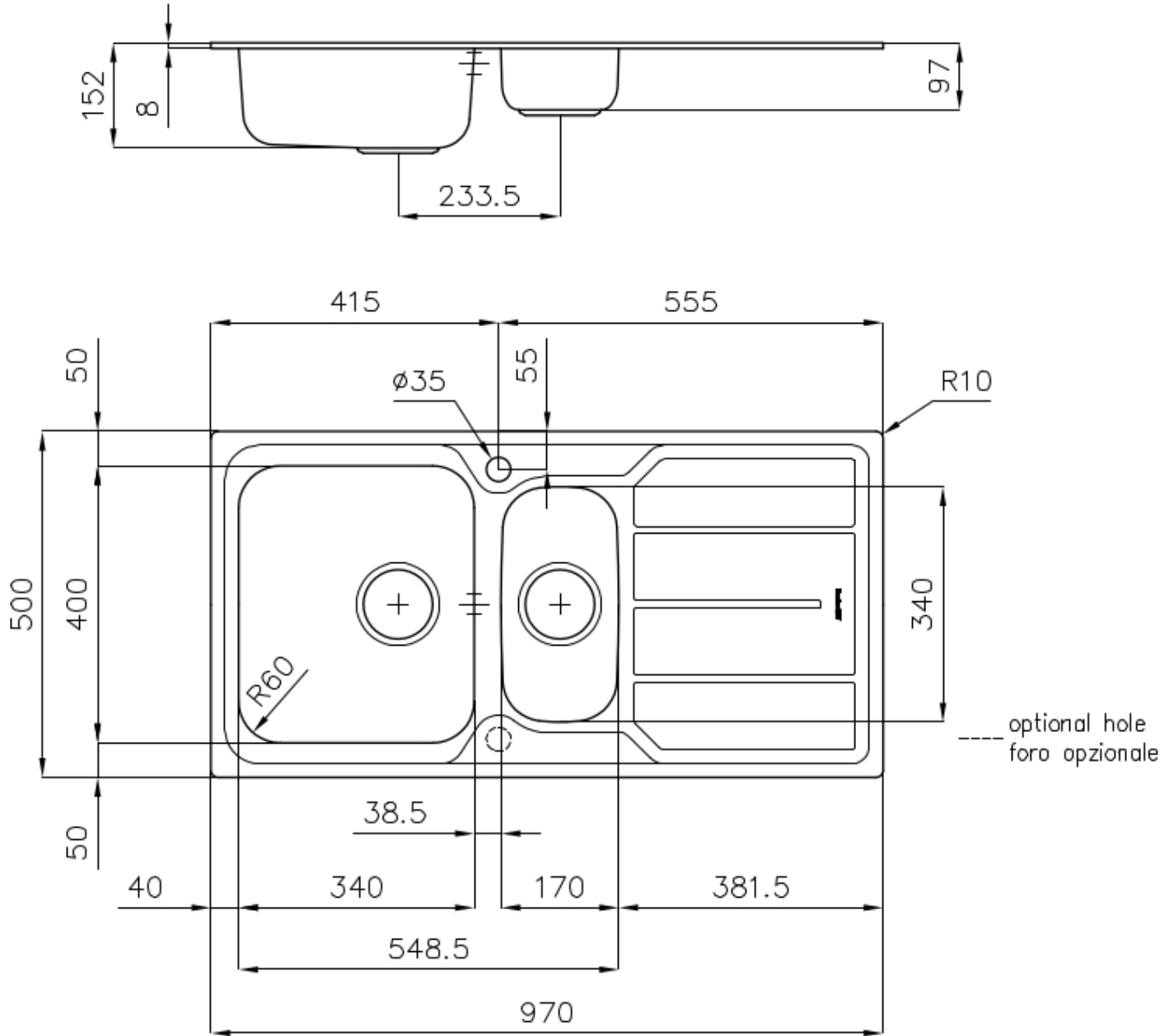

GALLERY



OPTIONAL ACCESSORIES



HPDE Chopping board



Iroko-wood sliding chopping board



Stainless steel basket

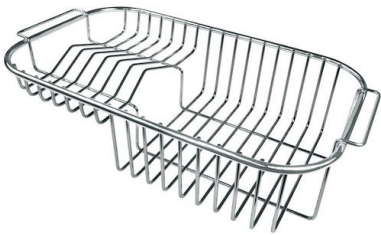

Stainless steel plate rack

RECOMMENDED PAIRINGS



Mixer Tap Lorenzo



Mixer Tap S1000 - RO

OPTIONAL AUTOMATIC WASTE FITTINGS



Automatic waste fitting



Automatic waste fitting



LIRA automatic waste fitting



LIRA automatic waste fitting