

Sink S1000 1186 16x

Kitchen Sinks

Code: 1186 16x

Code: 1186 161 DX (Sink on the right)

Code: 1186 162 SX (Sink on the left)



DETAILS

Finish Foster brushed

Material AISI 304 stainless steel

Texture Foster brushed

Base 45 cm

Edge/Installation Type Standard (8 mm Edge)

Dimensions 860x500 mm

Standard fittings Fixing hooks, gasket, drain, overflow and siphon, boxed packing

Mixer holes 1 standard hole

Built-in hole 840x480 mm

Drainer Yes

Width 86 cm

Bowl dimension 340x400mm

Number of bowls 1 bowl

Waste fitting 3,5" drain

FEATURES

Sliding brackets

Added value Foster uses steel thicknesses higher than those used on average by other manufacturers. This is how, thanks to our long experience, we know how to make sinks of superior quality and with a better resistance to aging.

Basket 3,5" waste fitting The drain is equipped with a large 3.5" drain, with the practical basket cap that prevents the discharge of solid parts.

TECHNICAL DATA

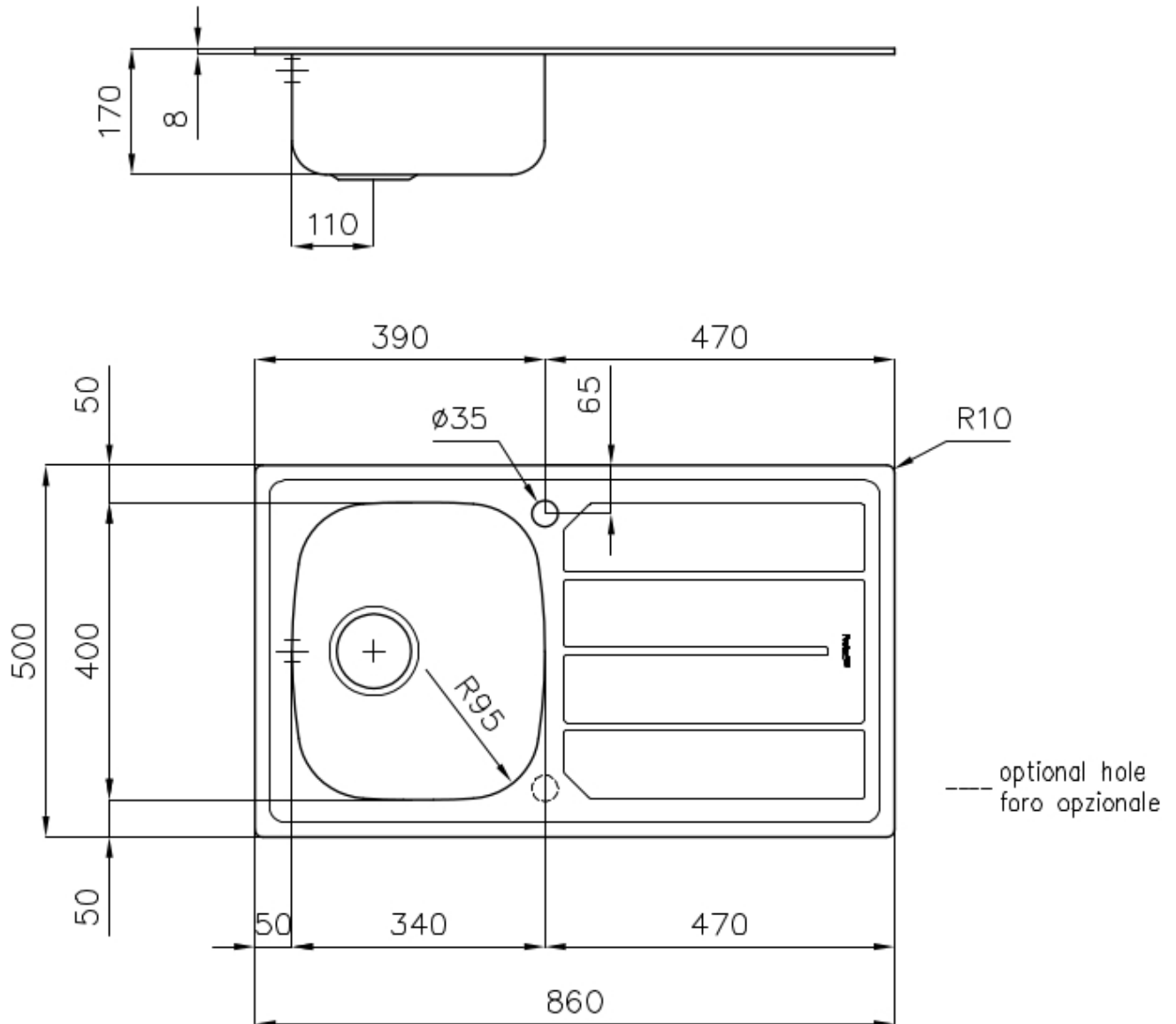

OPTIONAL ACCESSORIES



HPDE Chopping board 8657 001



Iroko-wood sliding chopping board 8643 000



Stainless steel basket 8611 000

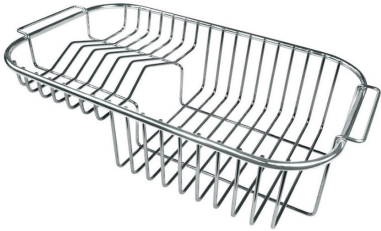

Stainless steel plate rack 8100 301

RECOMMENDED PAIRINGS



Mixer Tap Lorenzo 8466 000



Mixer Tap S1000 - RO 8443 002