

Sink Milanello workstation

Kitchen Sinks

Code: 1043 052



DETAILS

Edge/Installation Type	Flush-mount Top-mount
Finish	Foster brushed
Material	AISI 304 stainless steel
Texture	Brushed in line
Base	120 cm
Dimensions	1175x520 mm
Standard fittings	Fixing hooks, gasket, drain, overflow and siphon, boxed packing
Mixer holes	2 standard holes - 3rd hole on request
Built-in hole	View technical data sheet

Drainer	Yes
Width	117 cm
Bowl dimension	855x374mm
Number of bowls	1 bowl
Waste fitting	Drain with automatic control SPACE (PUSH)

EQUIPMENT

3 x Black grid Milanello 8100
602
1 x Space Push
automatic waste fitting 8407
116

FEATURES

2nd / 3rd hole available	The sink can be customized with the execution on request of additional holes, usable for double-hole mixers, for remote controlled drains or for the installation of soap dispensers. The positions are marked on the drawings with dotted line holes.
Automatic waste fitting	The waste-fitting with round remote knob is supplied; a practical accessory which makes it unnecessary to get wet in order to drain the water from the bowl.
Diamond-shape bottom	The draining of water is an important feature in a sink, and it's always taken good care of in Foster products. In the bent-welded sinks, which would have a flat bottom, the proper draining is guaranteed by the elegant beveling, which helps the water flow.
Double mixer hole	The large tap counter is already fitted with a series of 2 tap holes. In the second hole it is possible to install the remote control of the automatic drain or, alternatively, a practical soap dispenser.

High thickness

1mm thick steel. A significant thickness, which guarantees the maximum sturdiness and durability.

Perimetral overflow

The overflow is always a security on the Foster sinks that prevents the overflow of water in case of oversights. The perimeter drain solution improves aesthetics thanks to its square and essential shape.

Save space system

Drain and siphon are designed to leave as much space as possible in the under-sink area, more and more useful today for theseparate waste collection systems.

Space waste fitting

The elegant SPACE steel cap closes the drain and leaves no visible residues collected in the basket below. Space also has a small footprint and allows the optimal use of the under-sink compartment.

Triple recess - sliding accessories

The Foster Milano sink has an ingenious design that makes it simple to use a large set of optional accessories. On the topmost supporting step, the innovative Black grids slide, creating a large and practical surface to rinse food and crockery. The second step is meant to support and allow the sliding of a complete combination of accessories, which make some operations practical and safe: rinse, drain, slice, grate... everything can be done inside the sink. The third supporting step is on the bottom of the bowl. On this step one can rest the Black grids, making it possible to rinse foodstuffs without their coming in contact with the bottom of the sink, which may be dirty.

TECHNICAL DATA

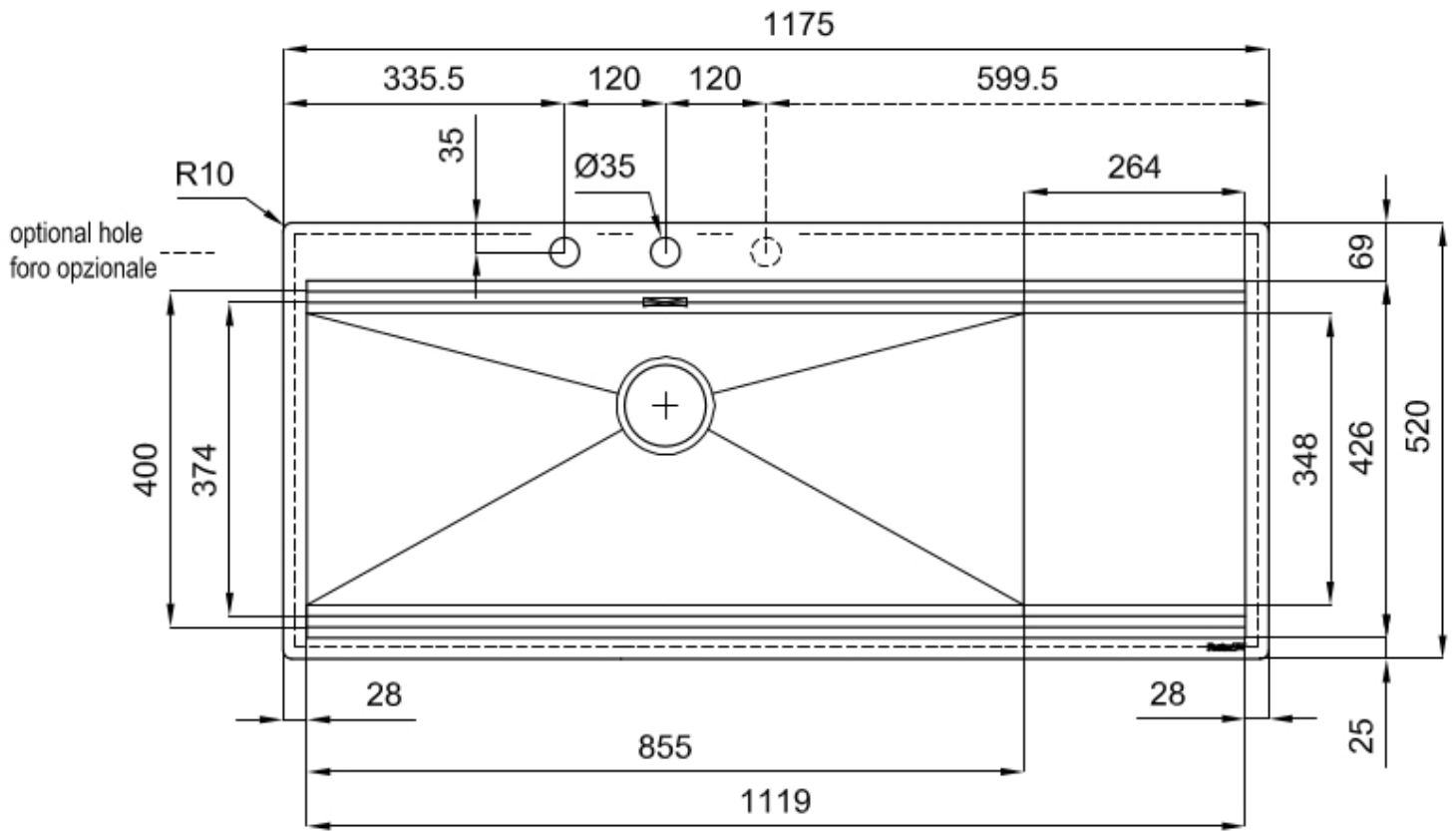
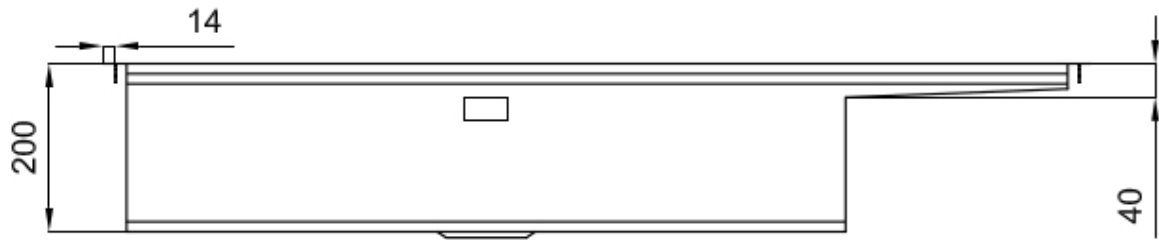

Milanello Optional accessories / Accessori opzionali

The "rails" system makes it possible to use a combination of numerous accessories. Grids, chopping boards, utensils' ranging system, bowls and containers of different dimensions can be alternated in the workspace with a simple gesture, and can easily be stacked, in order to be on hand at all times.

Il sistema di "corsie" rende possibile l'utilizzo combinato di innumerevoli accessori. Griglie, taglieri, portautensili, vaschette e contenitori di varie dimensioni si alternano nella zona di lavoro con un semplice gesto e possono essere impilati, sempre a portata di mano.



Milanello Level 1

Compatible accessories/Accessori compatibili:

8100	602
8631	300
8642	003
8644	004
8644	101
8657	001



Milanello Level 2

Compatible accessories/Accessori compatibili:

8100 306
8156 000

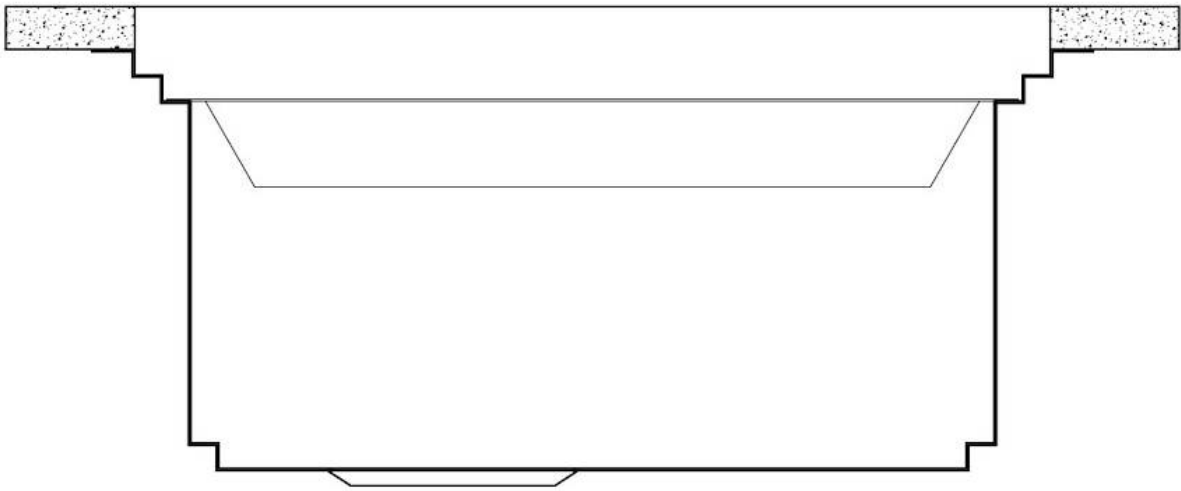

Milanello Level 3

Compatible accessories/Accessori compatibili:

8100 602

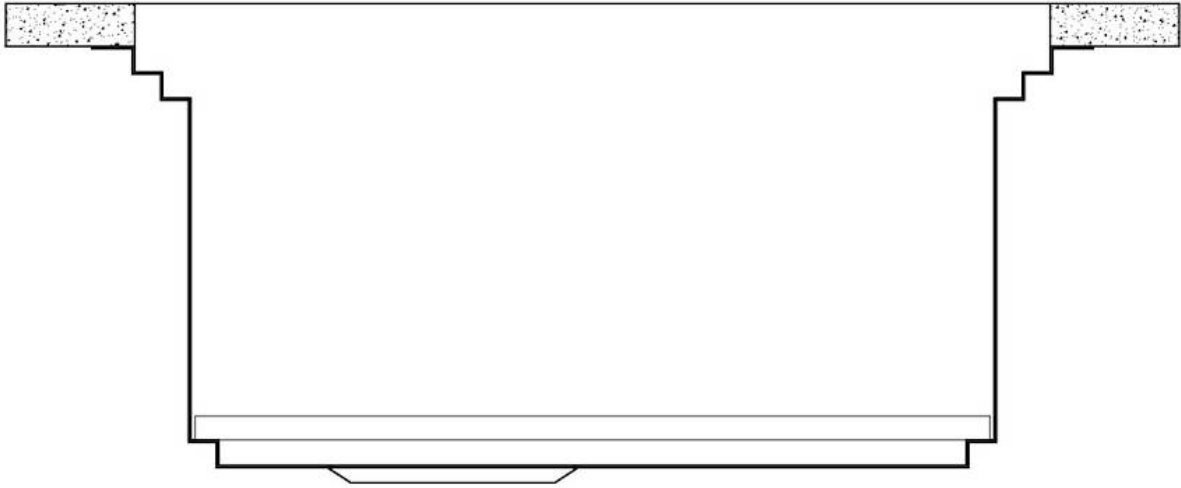

Lavello MILANELLO cod. 1043/05*

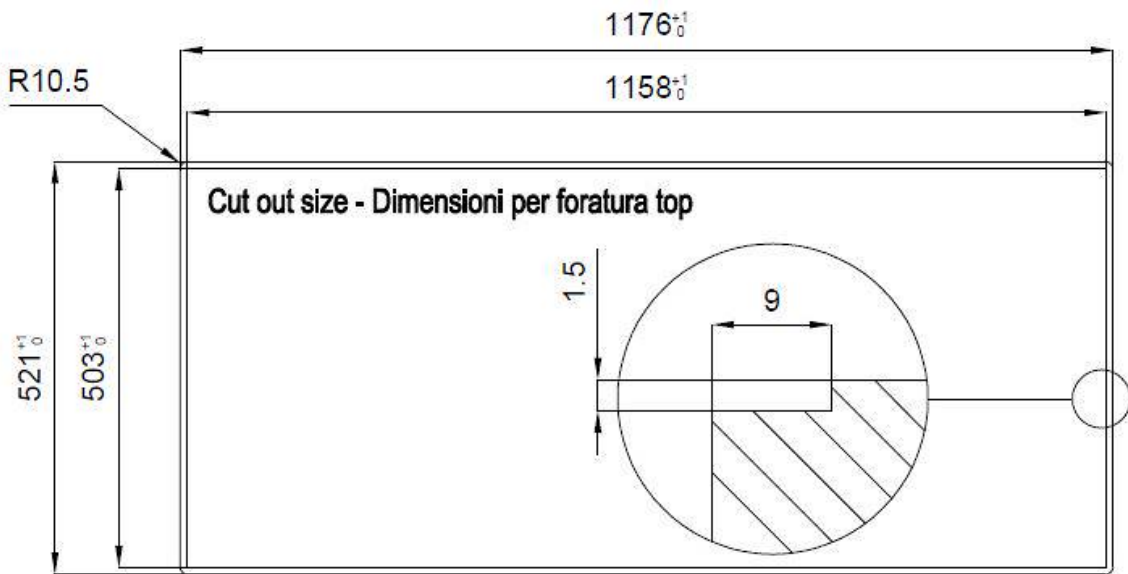

FT

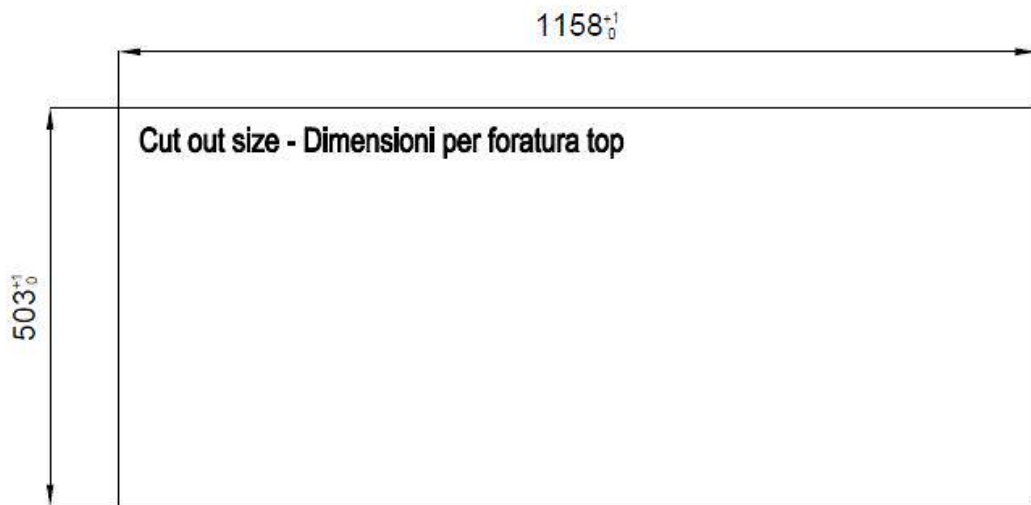

FTS

GALLERY

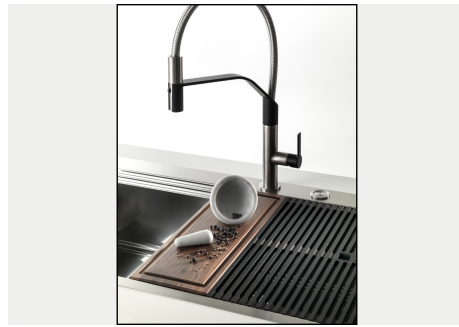
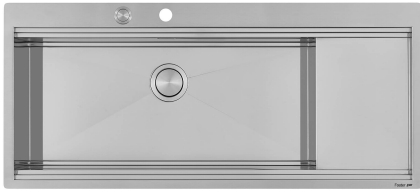

EQUIPMENT



Black grid Milanello



Space Push automatic waste fitting

OPTIONAL ACCESSORIES



HPDE Chopping board



HPDE Twin chopping board



Iroko-wood twin chopping board



Stainless steel colander



Stainless steel perforated tray



Stainless steel plate rack



Stainless steel plate rack

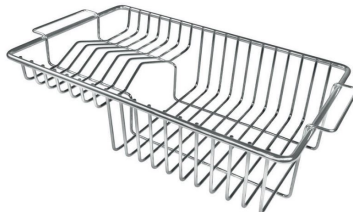

Stainless steel Plate rack



Walnut-wood chopping board



Glass chopping board



Graters kit with ring-holder and food collection tray



Stainless steel perforated tray

WARNING:

The accessories 8159101, 8100303,8151000 are only usable in combination with 8644101

The accessories 8100154, 8154000 are only usable in combination with 8644004

RECOMMENDED PAIRINGS

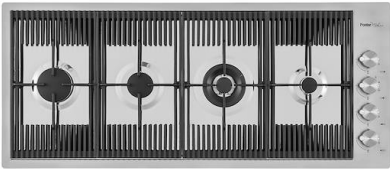

Cooker hob Milanello



Mixer Tap Milanello