

Sink Milanello Gold workstation

Kitchen Sinks

Code: 1034 059



DETAILS

Coloring Gold

Edge/Installation Type Flush-mount | Top-mount

Finish PVD

Material AISI 304 stainless steel

Texture Brushed in line

Base 80 cm

Dimensions 806 x 520 mm

Standard fittings Fixing hooks, gasket, drain, overflow and siphon, boxed packing

Mixer holes 2 standard holes - 3rd hole on request

Built-in hole

[View technical data sheet](#)

Drainer

No

Width

81 cm

Bowl dimension

750 x 374 mm

Number of bowls

1 bowl

Waste fitting

Drain with automatic control SPACE PUSH GOLD - PD

EQUIPMENT

2 x Black grid Milanello 8100
602

1 x Space Push Gold
automatic waste fitting 8407
121

FEATURES

Gold

The Gold finish is obtained by treating the steel with a physical process called PVD (Physical Vacuum Deposition) which deposits particles of noble metals on the surface. The result is a unique and refined aesthetic effect, and an improvement in the mechanical properties of the steel that is more resistant to shocks and scratches.

ADDITIONAL HOLES
AVAILABLE

The sink can be customized with the execution on request of additional holes, usable for double-hole mixers, for remote controlled drains or for the installation of soap dispensers. The positions are marked on the drawings with dotted line holes.

Automatic waste fitting

The waste-fitting with round remote knob is supplied; a practical accessory which makes it unnecessary to get wet in order to drain the water from the bowl.

Diamond-shape bottom

The draining of water is an important feature in a sink, and it's always taken good care of in Foster products. In the bent-welded sinks, which would have a flat bottom, the proper draining is guaranteed by the elegant beveling, which helps the water flow.

Double mixer hole

The large tap counter is already fitted with a series of 2 tap holes. In the second hole it is possible to install the remote control of the automatic drain or, alternatively, a practical soap dispenser.

High thickness

1mm thick steel. A significant thickness, which guarantees the maximum sturdiness and durability.

Perimetral overflow

The overflow is always a security on the Foster sinks that prevents the overflow of water in case of oversights. The perimeter drain solution improves aesthetics thanks to its square and essential shape.

Save space system

Drain and siphon are designed to leave as much space as possible in the under-sink area, more and more useful today for theseparate waste collection systems.

Small radius

Bowls with squared shapes with a modern design and an increased capacity, for a minimal aesthetics connected with an extreme praticity.

Space waste fitting

The elegant SPACE steel cap closes the drain and leaves no visible residues collected in the basket below. Space also has a small footprint and allows the optimal use of the under-sink compartment.

Triple recess - sliding accessories

The Foster Milano sink has an ingenious design that makes it simple to use a large set of optional accessories. On the topmost supporting step, the innovative Black grids slide, creating a large and practical surface to rinse food and crockery. The second step is meant to support and allow the sliding of a complete combination of accessories, which make some operations practical and safe: rinse, drain, slice, grate... everything can be done inside the sink. The third supporting step is on the bottom of the bowl. On this step one can rest the Black grids, making it possible to rinse foodstuffs without their coming in contact with the bottom of the sink, which may be dirty.

TECHNICAL DATA

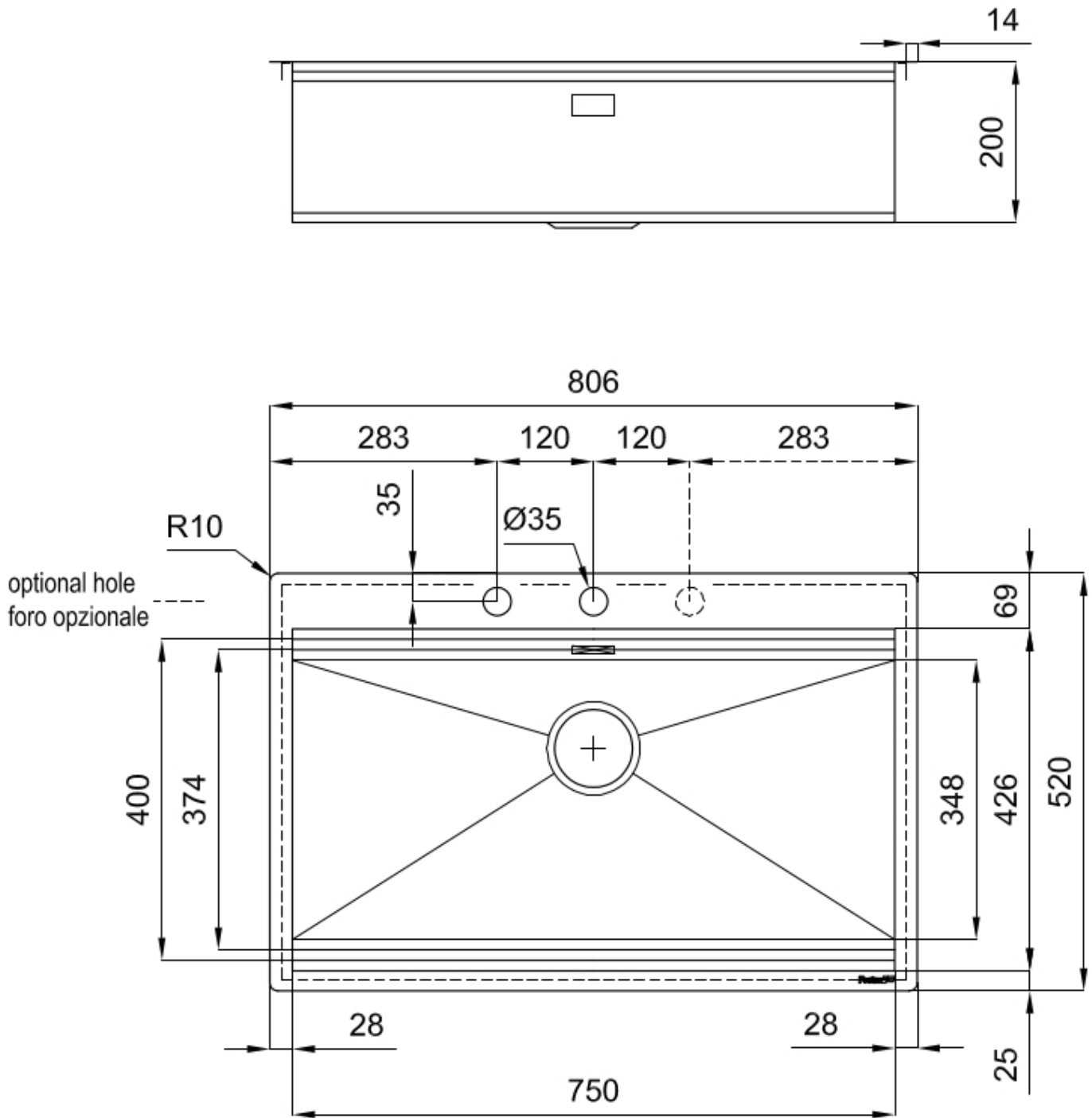

Milanello Optional accessories / Accessori opzionali

The "rails" system makes it possible to use a combination of numerous accessories. Grids, chopping boards, utensils' ranging system, bowls and containers of different dimensions can be alternated in the workspace with a simple gesture, and can easily be stacked, in order to be on hand at all times.

Il sistema di "corsie" rende possibile l'utilizzo combinato di innumerevoli accessori. Griglie, taglieri, portautensili, vaschette e contenitori di varie dimensioni si alternano nella zona di lavoro con un semplice gesto e possono essere impilati, sempre a portata di mano.



Milanello Level 1

Compatible accessories/Accessori compatibili:

8100 602
8631 300
8642 003
8644 004
8644 101
8657 001

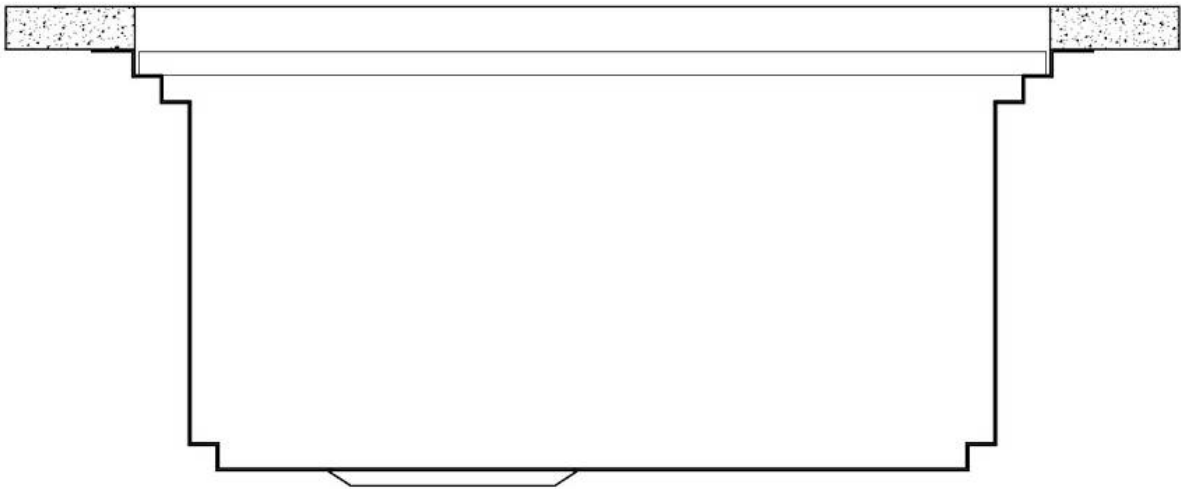

Milanello Level 2

Compatible accessories/Accessori compatibili:

8100 306

8156 000



Milanello Level 3

Compatible accessories/Accessori compatibili:

8100 602



Lavello MILANELLO cod. 1034/05*



FT

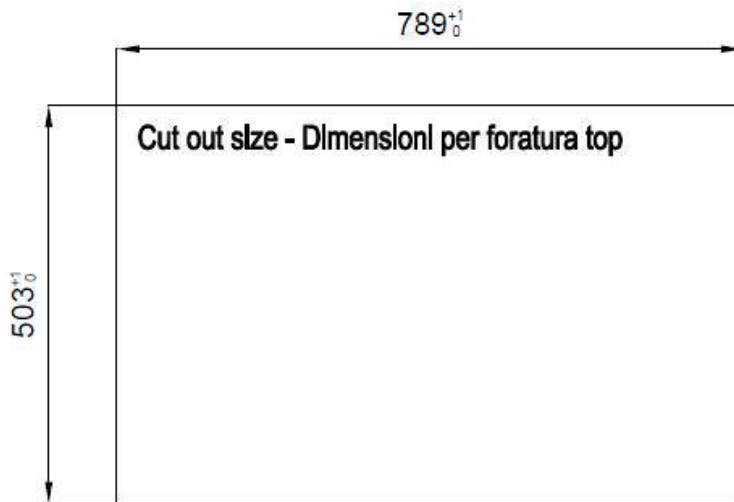

FTS

GALLERY

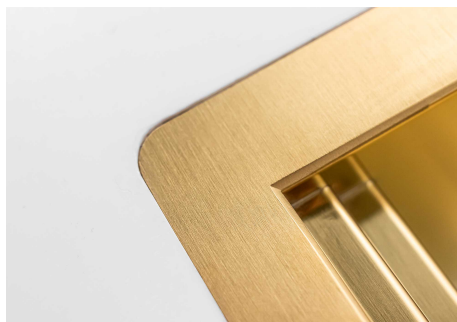

EQUIPMENT



Black grid Milanello
8100 602



Space Push Gold automatic waste fitting
8407 121

OPTIONAL ACCESSORIES



HDPE Chopping board
8657 001



HPDE Twin chopping board
8644 101



Stainless steel perforated tray
8156 000

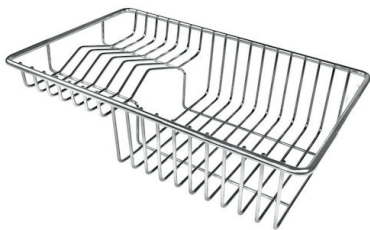

Stainless steel plate rack
8100 303

* only in combination with the accessory
8644 101



Glass chopping board
8631 300



Graters kit with ring-holder and food collection tray
8159 101

* only in combination with the accessory
8644 101



**Iroko-wood sliding chopping board
with stainless steel colander**

8644 044



Stainless steel perforated tray

8151 000

* only in combination with the accessory
8644 101



**Stainless steel perforated tray PVD
Gold**

8151 009

* only in combination with the accessory
8644 101



Walnut-wood chopping board

8642 004

RECOMMENDED PAIRINGS

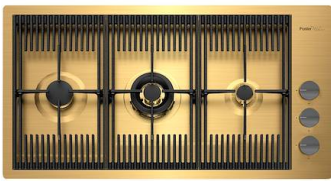

Cooker hob Milanello Gold

7680 009

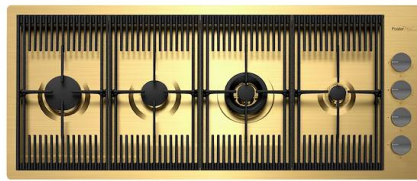

Cooker hob Milanello Gold

7681 009



Mixer Tap Omega Gold

8497 700