

Sink Foster Milano

Kitchen Sinks

Code: 1011 050



DETAILS

Edge/Installation Type Flush-mount | Top-mount

Finish Foster brushed

Material AISI 304 stainless steel

Texture Brushed in line

Base 60 cm

Dimensions 518x560 mm

Standard fittings Fixing hooks, gasket, drain, overflow and siphon, boxed packing

Mixer holes 2 standard holes

Built-in hole [View technical data sheet](#)

Drainer	No
Width	52 cm
Bowl dimension	462x400mm
Number of bowls	1 bowl
Waste fitting	Drain with automatic control SPACE MILANO - 3.5 "

FEATURES

56 cm deep	56 cm deep. An increased dimension synonymous with great functionality, which distinguishes the Foster Milano series.
Automatic waste fitting	The waste-fitting with round remote knob is supplied; a practical accessory which makes it unnecessary to get wet in order to drain the water from the bowl.
Diamond-shape bottom	The draining of water is an important feature in a sink, and it's always taken good care of in Foster products. In the bent-welded sinks, which would have a flat bottom, the proper draining is guaranteed by the elegant beveling, which helps the water flow.
Double mixer hole	The large tap counter is already fitted with a series of 2 tap holes. In the second hole it is possible to install the remote control of the automatic drain or, alternatively, a practical soap dispenser.
High thickness	1mm thick steel. A significant thickness, which guarantees the maximum sturdiness and durability.
Perimetral overflow	The overflow is always a security on the Foster sinks that prevents the overflow of water in case of oversights. The perimeter drain solution improves aesthetics thanks to its square and essential shape.
Save space system	Drain and siphon are designed to leave as much space as possible in the under-sink area, more and more useful today for theseparate waste collection systems.

Space waste fitting

The elegant SPACE steel cap closes the drain and leaves no visible residues collected in the basket below. Space also has a small footprint and allows the optimal use of the under-sink compartment.

Triple recess - sliding accessories

The Foster Milano sink has an ingenious design that makes it simple to use a large set of optional accessories. On the topmost supporting step, the innovative Black grids slide, creating a large and practical surface to rinse food and crockery. The second step is meant to support and allow the sliding of a complete combination of accessories, which make some operations practical and safe: rinse, drain, slice, grate... everything can be done inside the sink. The third supporting step is on the bottom of the bowl. On this step one can rest the Black grids, making it possible to rinse foodstuffs without their coming in contact with the bottom of the sink, which may be dirty.

TECHNICAL DATA

Milano Optional accessories / Accessori opzionali

The "rails" system makes it possible to use a combination of numerous accessories. Grids, chopping boards, utensils' ranging system, bowls and containers of different dimensions can be alternated in the workspace with a simple gesture, and can easily be stacked, in order to be on hand at all times.

Il sistema di "corsie" rende possibile l'utilizzo combinato di innumerevoli accessori. Griglie, taglieri, portautensili, vaschette e contenitori di varie dimensioni si alternano nella zona di lavoro con un semplice gesto e possono essere impilati, sempre a portata di mano.



Milano Level 1

Compatible accessories/Accessori compatibili:

8100 600

8642 000



Milano Level 2

Compatible accessories/Accessori compatibili:

8153	100
8631	300
8644	101



Milano Level 3

Compatible accessories/Accessori compatibili:

8100 600



Lavello MILANO

cod. 1011/050

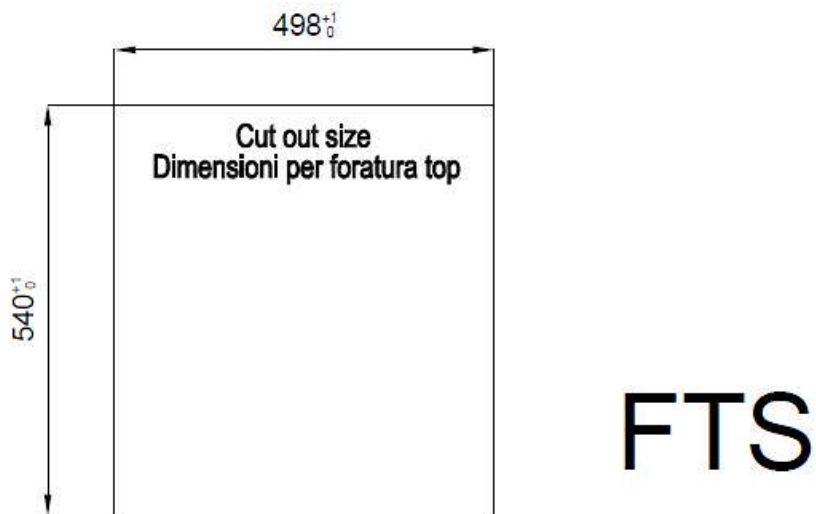
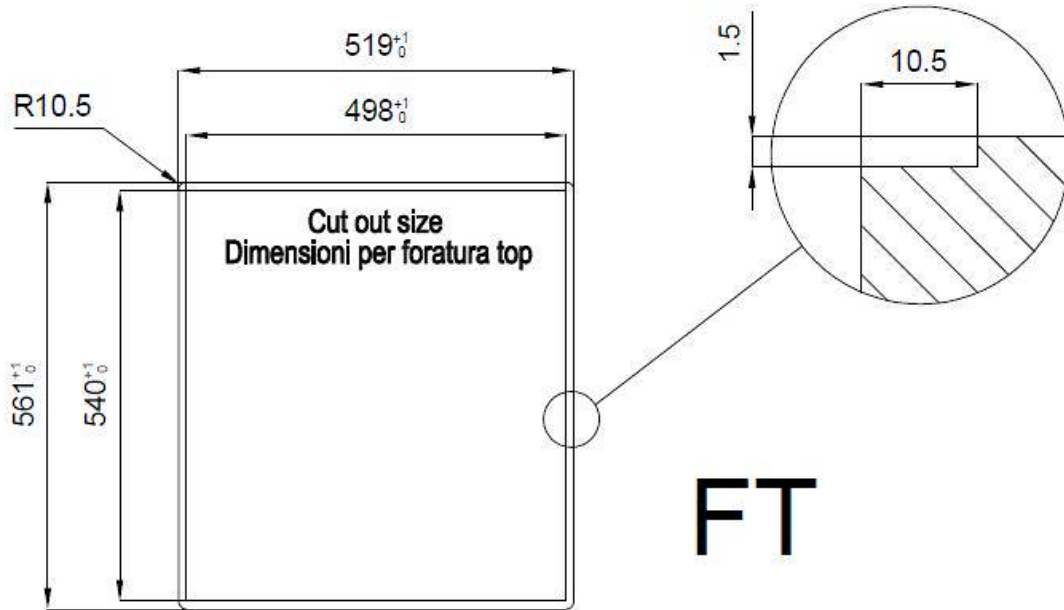

GALLERY



EQUIPMENT



Space Milano automatic waste fitting
8407 115

OPTIONAL ACCESSORIES



Black grid
8100 600



HPDE Twin chopping board
8644 101



Stainless steel plate rack
8100 303
* only in combination with the accessory
8644 101



Walnut-wood chopping board
8642 000



3 Bottles-holder set
8100 621



3 Bowls set
8100 622



4 Spices-holder set
8100 620



Foldable rack
8110 000



Glass chopping board
8631 300



**Graters kit with ring-holder and
food collection tray**
8159 101
* only in combination with the accessory
8644 101



**Iroko-wood sliding chopping board
with stainless steel colander**
8644 044



Kit Black
8100 037



Kit multi-bowl
8100 628



Knives-holder
8100 030
* only in combination with the accessory
8100 621



Stainless steel colander
8151 010



Stainless steel perforated tray
8151 000
* only in combination with the accessory
8644 101



Stainless steel perforated tray
8151 001



White bowl
8153 100

RECOMMENDED PAIRINGS



Cooker hob Foster Milano
7637 000



Mixer Tap FL
8521 000